

2009 Ninja® 500R PARTS DIAGRAM

Radiator

E3032

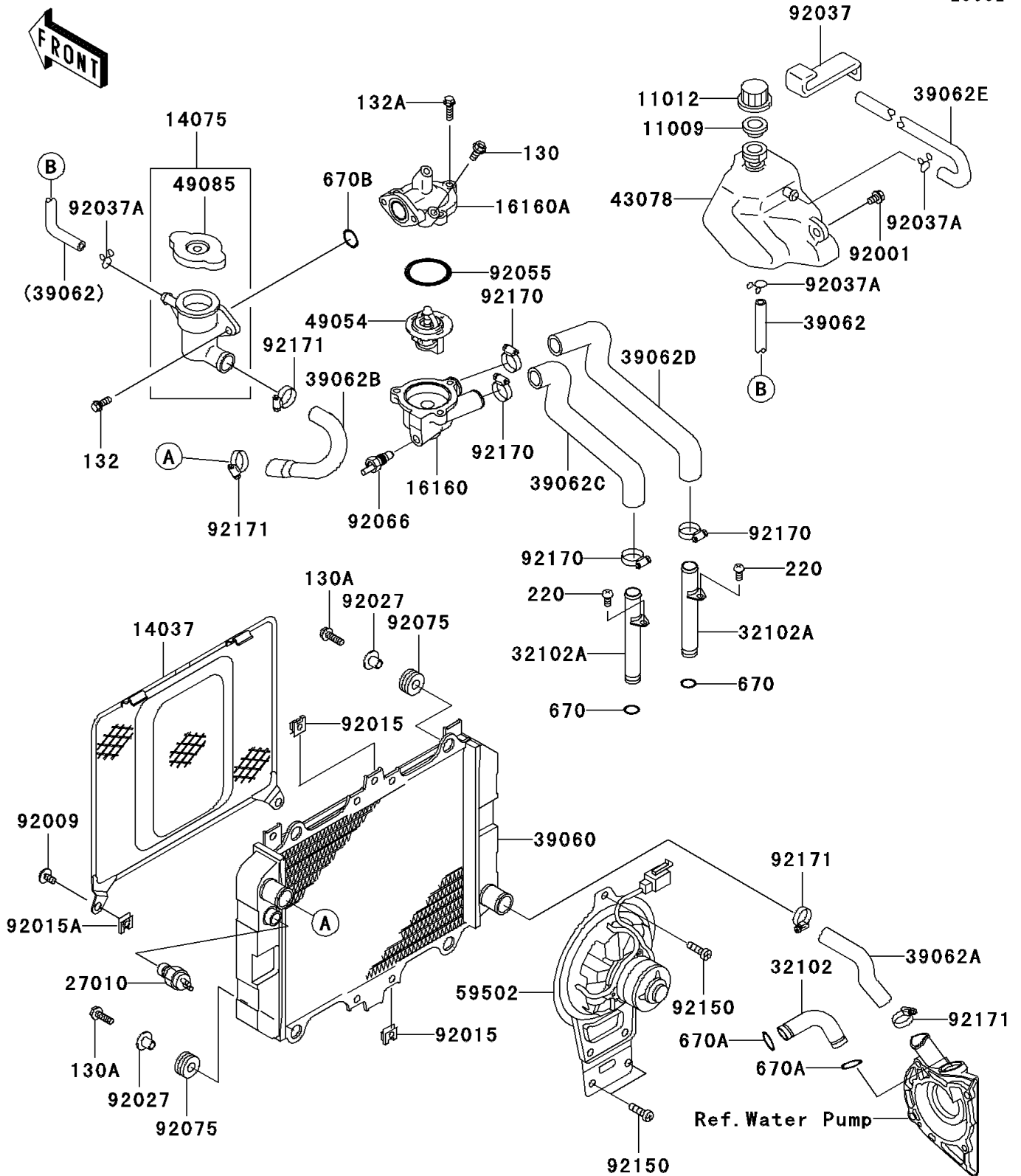

2009 Ninja® 500R PARTS LIST

Radiator

ITEM NAME	PART NUMBER	QUANTITY
GASKET,RESERVOIR TANK CAP (Ref # 11009)	11009-1145	1
CAP (Ref # 11012)	11012-1084	1
SCREEN (Ref # 14037)	14037-1143	1
CAP-ASSY,RADIATOR (Ref # 14075)	14075-1085	1
BODY,THERMOSTAT,LWR (Ref # 16160)	16160-1138	1
BODY,THERMOSTAT,UPP (Ref # 16160A)	16160-1170	1
SWITCH,THERMOSTAT (Ref # 27010)	27010-1304	1
PIPE,PUMP-CYLINDER (Ref # 32102)	32102-1405	1
PIPE (Ref # 32102A)	32102-1473	2
RADIATOR (Ref # 39060)	39060-1084	1
HOSE-COOLING,L=447 (Ref # 39062)	39062-1195	1
HOSE-COOLING,RADIATOR-PUMP (Ref # 39062A)	39062-1222	1
HOSE-COOLING,CAP-RADIATOR (Ref # 39062B)	39062-1223	1
HOSE-COOLING,THERMO-HEAD,LH (Ref # 39062C)	39062-1224	1
HOSE-COOLING,THERMO-HEAD,RH (Ref # 39062D)	39062-1225	1
HOSE-COOLING (Ref # 39062E)	39062-1257	1
RESERVOIR (Ref # 43078)	43078-1084	1
THERMOSTAT (Ref # 49054)	49054-1059	1
CAP-ASSY-PRESSURE (Ref # 49085)	49085-1066	1
FAN-ASSY (Ref # 59502)	59502-0018	1
BOLT,W/WASHER,6X12 (Ref # 92001)	92001-1516	2
SCREW,6X12 (Ref # 92009)	92009-1480	2
NUT (Ref # 92015)	92015-1487	3
NUT,6MM (Ref # 92015A)	92015-1758	2
COLLAR,FLANGED,L=12.1,BLACK (Ref # 92027)	92027-1651	4
CLAMP,HARNESS (Ref # 92037)	92037-1316	1
CLAMP,TUBE (Ref # 92037A)	92037-147	3
RING-O,44.7X2.4 (Ref # 92055)	92055-1279	1
PLUG,SENSOR,WATER (Ref # 92066)	92066-1118	1

2009 Ninja® 500R PARTS LIST

Radiator

ITEM NAME	PART NUMBER	QUANTITY
DAMPER (Ref # 92075)	92075-277	4
BOLT,6X12 (Ref # 92150)	92150-1186	3
CLAMP,HOSE,26MM (Ref # 92170)	92170-1077	4
CLAMP (Ref # 92171)	92171-0261	4
BOLT-FLANGED,6X14 (Ref # 130)	130AA0614	2
BOLT-FLANGED,6X20 (Ref # 130A)	130BB0620	4
BOLT-FLANGED-SMALL,6X16 (Ref # 132)	132BA0616	2
BOLT-FLANGED-SMALL,6X20 (Ref # 132A)	132BA0620	3
SCREW-PAN-CROSS,6X12 (Ref # 220)	220AA0612	2
O RING,14MM (Ref # 670)	670B2014	2
O RING,18MM (Ref # 670A)	670B2018	2
O RING,20MM (Ref # 670B)	670B2020	1