

1990 Bayou 300 PARTS DIAGRAM

Crankshaft

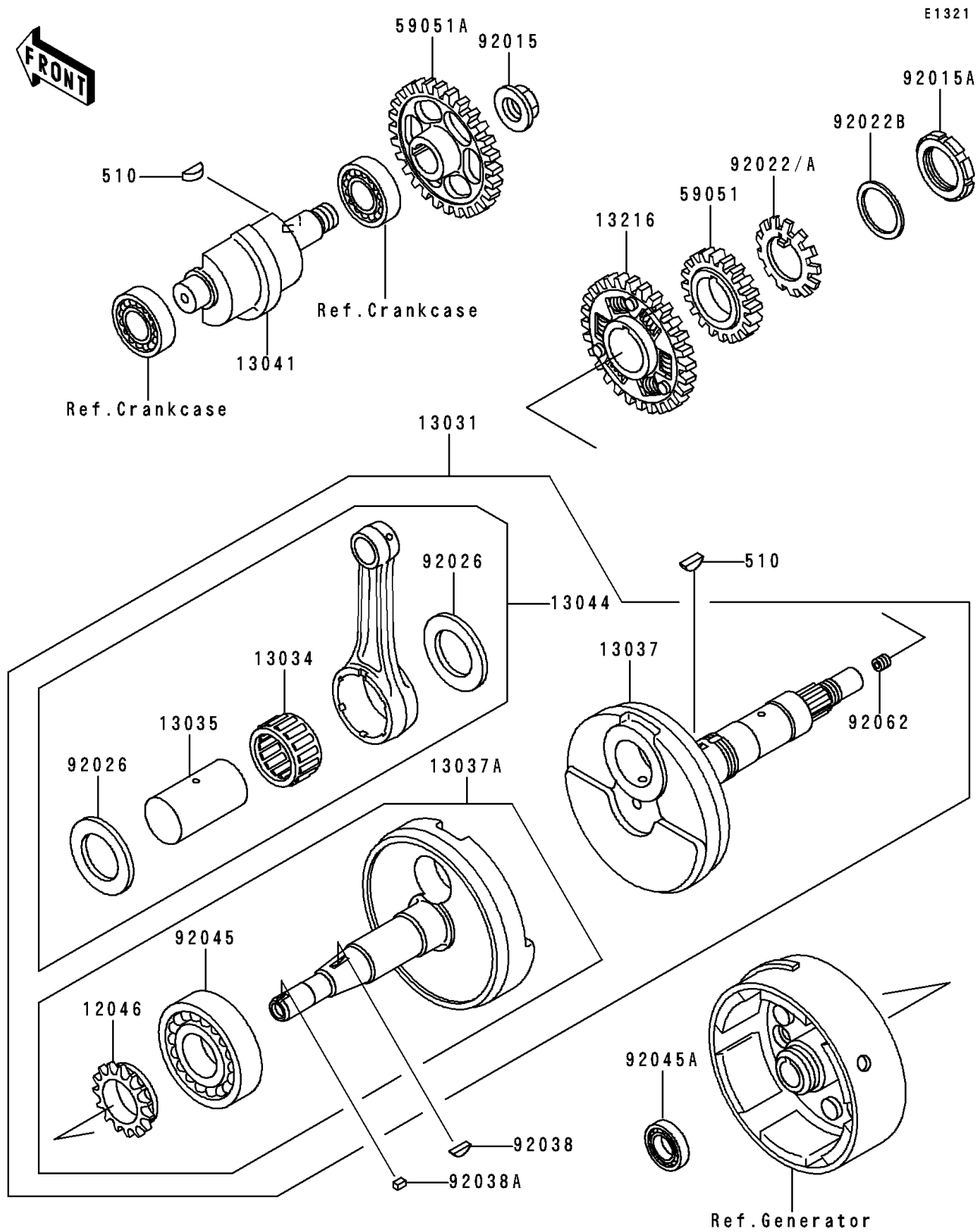

1990 Bayou 300 PARTS LIST

Crankshaft

ITEM NAME	PART NUMBER	QUANTITY
KEY-WOODRUFF (Ref # 510)	510A5100	2
SPROCKET,16T (Ref # 12046)	12046-1038	1
CRANKSHAFT-COMP (Ref # 13031)	13031-1254	1
BEARING-BIG END,PK32X43X22.4 (Ref # 13034)	13034-1061	1
PIN-CRANK (Ref # 13035)	13035-1067	1
CRANKSHAFT,RH (Ref # 13037)	13037-1268	1
CRANKSHAFT,LH (Ref # 13037A)	13037-5075	1
BALANCER (Ref # 13041)	13041-1066	1
SET-CONNECTING ROD (Ref # 13044)	13044-5066	1
GEAR-COMP,BALANCER (Ref # 13216)	13216-1072	1
GEAR-SPUR,OIL PUMP,36T (Ref # 59051)	59051-1140	1
GEAR-SPUR,BALANCER,44T (Ref # 59051A)	59051-1141	1
NUT,16MM (Ref # 92015)	92015-1465	1
NUT,PUMP GEAR,30MM (Ref # 92015A)	92015-1511	1
WASHER,TOOTHED (Ref # 92022A)	92022-1986	1
WASHER,30.3X38X0.5 (Ref # 92022B)	92022-1987	1
SPACER,32X51.5X1.2 (Ref # 92026)	92026-1232	2
KEY,WOODRUFF (Ref # 92038)	92038-001	1
KEY,SUNK (Ref # 92038A)	92038-1051	1
BEARING-BALL,#6306 (Ref # 92045)	92045-037	1
BEARING-BALL,#6903C3 (Ref # 92045A)	92045-1131	1
NOZZLE (Ref # 92062)	92062-1056	1