

1991 Bayou 300 PARTS DIAGRAM

Label

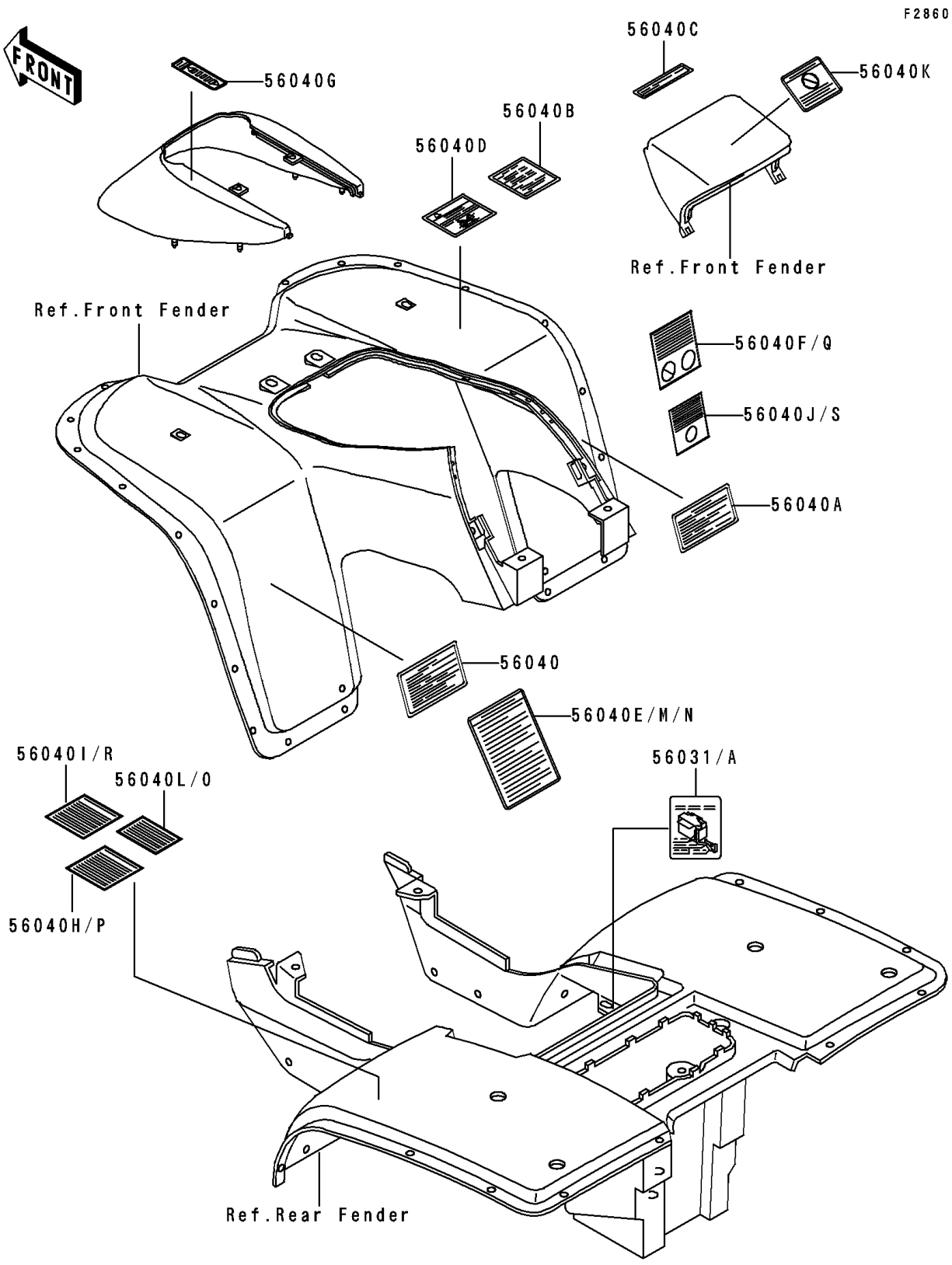

F2860

1991 Bayou 300 PARTS LIST

Label

ITEM NAME	PART NUMBER	QUANTITY
LABEL-MANUAL,BATTERY VENT (Ref # 56031A)	56031-1607	1
LABEL-WARNING,TRANSPORT (Ref # 56040F)	56040-1261	1
LABEL-WARNING,SHIFT PATTERN (Ref # 56040G)	56040-1262	1
LABEL-WARNING,TIRE PRESSURE (Ref # 56040H)	56040-1272	1
LABEL-WARNING,LOAD (Ref # 56040I)	56040-1274	1
LABEL-WARNING,DIFFERENTIAL (Ref # 56040J)	56040-1275	1
LABEL-WARNING,NO PASSENGER (Ref # 56040L)	56040-1277	1
LABEL-WARNING,SERIOUS INJURY (Ref # 56040E)	56040-1256	1
LABEL-WARNING,UNDER 16 (Ref # 56040K)	56040-1276	1
LABEL-WARNING,GENERAL (Ref # 56040M)	56040-1278	1
LABEL-WARNING,GENERAL (Ref # 56040N)	56040-1279	1
LABEL-WARNING,NO PASSENGER (Ref # 56040O)	56040-1280	1
LABEL-WARNING,TIRE PRESSURE (Ref # 56040P)	56040-1281	1
LABEL-WARNING,TRANSPORT (Ref # 56040Q)	56040-1283	1
LABEL-WARNING,LOAD CAPACITY (Ref # 56040R)	56040-1284	1
LABEL-WARNING,DIFFERENTIAL (Ref # 56040S)	56040-1285	1