

# 1997 Bayou 300 PARTS DIAGRAM

Rear Hub

F2240

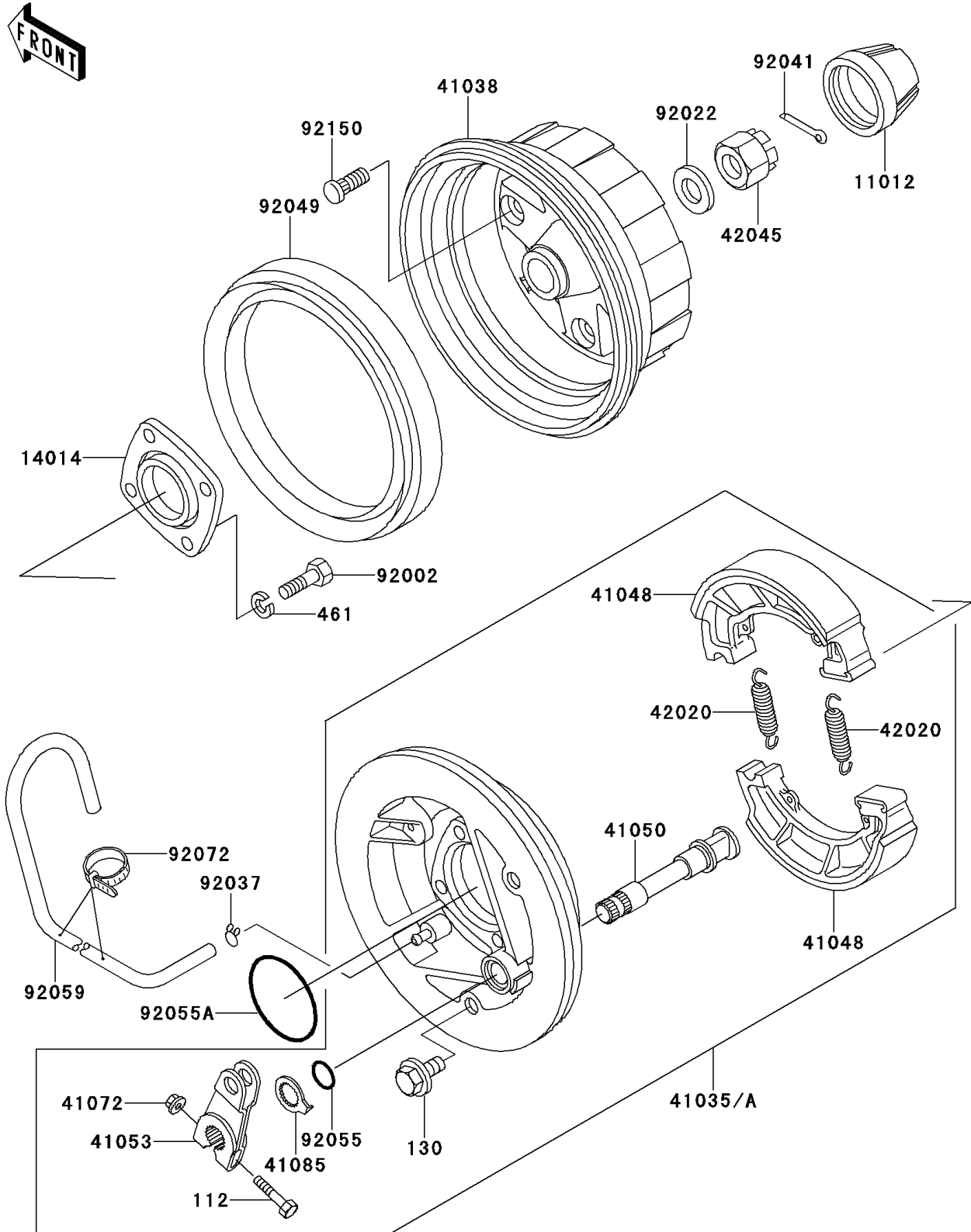

# 1997 Bayou 300 PARTS LIST

## Rear Hub

ITEM NAME	PART NUMBER	QUANTITY
BOLT-UPSET (Ref # 112)	112H0640	2
BOLT-FLANGED,10X16 (Ref # 130)	130B1016	2
WASHER-SPRING,10MM (Ref # 461)	461F1000	8
CAP,WHEEL (Ref # 11012)	11012-1969	2
PLATE-POSITION (Ref # 14014)	14014-1072	2
PANEL-ASSY-BRAKE,RR,RH (Ref # 41035)	41035-1239	1
PANEL-ASSY-BRAKE,RR,LH (Ref # 41035A)	41035-1273	1
DRUM,RR (Ref # 41038)	41038-1201	2
SHOE-BRAKE (Ref # 41048)	41048-1069	4
CAM-BRAKE (Ref # 41050)	41050-1074	2
LEVER-BRAKE CAM (Ref # 41053)	41053-1064	2
NUT,6MM (Ref # 41072)	41072-007	2
INDICATOR (Ref # 41085)	41085-1053	2
SPRING,BRAKE SHOE (Ref # 42020)	42020-004	4
NUT,CASTLE,18MM (Ref # 42045)	42045-018	2
BOLT,10X30 (Ref # 92002)	92002-1918	8
WASHER,18.3X34X4.5 (Ref # 92022)	92022-1658	2
CLAMP,TUBE (Ref # 92037)	92037-147	2
COTTER,4.0X35 (Ref # 92041)	92041-1053	2
SEAL-OIL (Ref # 92049)	92049-1242	2
RING-O,ID=16.4 (Ref # 92055)	92055-1376	2
RING-O (Ref # 92055A)	92055-3018	2
TUBE,4.7X9.5X1240 (Ref # 92059)	92059-1968	2
BAND,L=123 (Ref # 92072)	92072-030	5
BOLT,10MM (Ref # 92150)	92150-1110	8