

# 1991 Bayou 300 4X4 PARTS DIAGRAM

Gear Change Mechanism

E1370

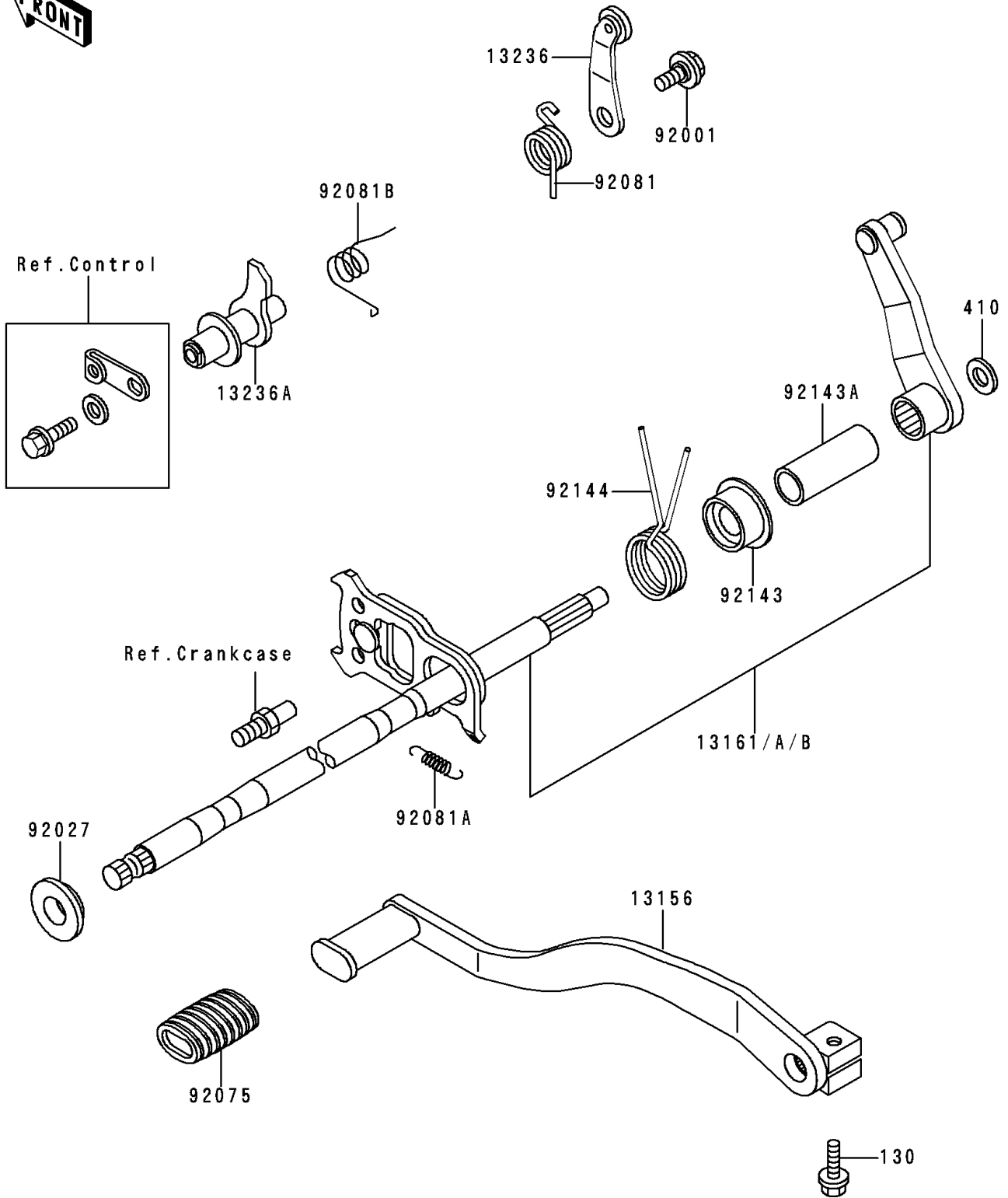

# 1991 Bayou 300 4X4 PARTS LIST

## Gear Change Mechanism

ITEM NAME	PART NUMBER	QUANTITY
BOLT-FLANGED,6X20,BLACK (Ref # 130)	130S0620	1
WASHER-PLAIN-SMALL,8MM (Ref # 410)	410B0800	1
LEVER-CHANGE,PEDAL (Ref # 13156)	13156-1248	1
LEVER-COMP-CHANGE SHAFT (Ref # 13161)	13161-1164	1
LEVER-COMP-CHANGE SHAFT (Ref # 13161B)	13161-1174	1
LEVER-COMP,CHANGE DRUM (Ref # 13236)	13236-1133	1
LEVER-COMP,REVERSE (Ref # 13236A)	13236-1238	1
BOLT,GEAR CHANGE LEVER (Ref # 92001)	92001-1715	1
COLLAR,L=5.2 (Ref # 92027)	92027-1891	1
DAMPER,CHANGE PEDAL (Ref # 92075)	92075-1585	1
SPRING (Ref # 92081)	92081-1496	1
SPRING,CHANGE LEVER (Ref # 92081A)	92081-1753	1
SPRING,REVERSE LEVER (Ref # 92081B)	92081-1850	1
COLLAR (Ref # 92143)	92143-1321	1
COLLAR,13.3X17.3X44.7 (Ref # 92143A)	92143-1574	1
SPRING,CHANGE SHAFT RETURN (Ref # 92144)	92144-1359	1