

# 1989 Bayou 300 4X4 PARTS DIAGRAM

Engine Cover(s)

E1431

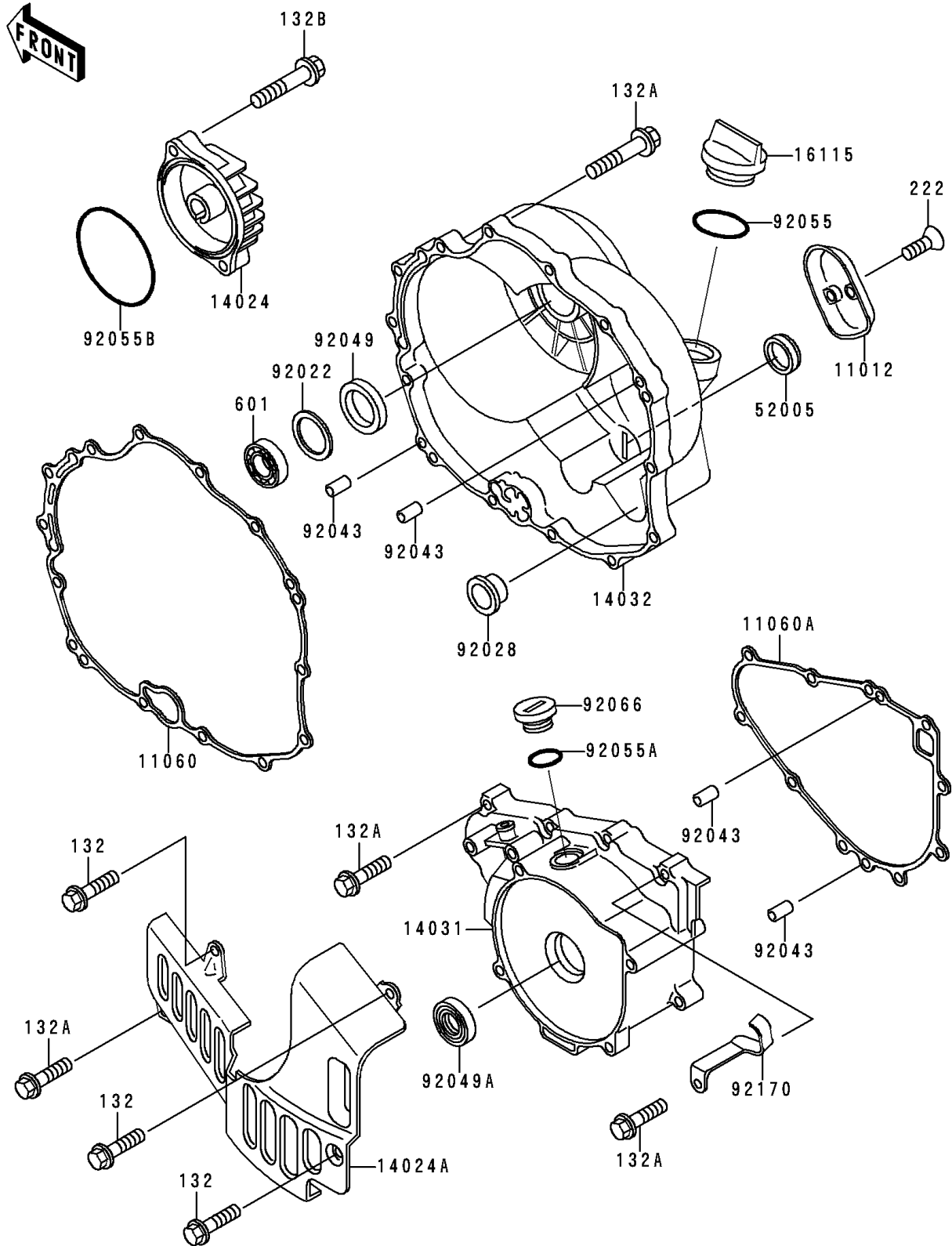

# 1989 Bayou 300 4X4 PARTS LIST

## Engine Cover(s)

ITEM NAME	PART NUMBER	QUANTITY
BOLT-FLANGED-SMALL (Ref # 132)	132J0612	3
BOLT-FLANGED-SMALL (Ref # 132A)	132J0630	23
BOLT-FLANGED-SMALL (Ref # 132B)	132Y0625	2
SCREW-CSK-RD-CROS (Ref # 222)	222C0512	2
BEARING-BALL,#6202C3 (Ref # 601)	601B6202	1
CAP,CLUTCH RELEASE (Ref # 11012)	11012-1644	1
GASKET,CLUTCH COVER (Ref # 11060)	11060-1230	1
GASKET,GENERATOR COVER (Ref # 11060A)	11060-1231	1
COVER,OIL FILTER (Ref # 14024)	14024-1062	1
COVER (Ref # 14024A)	14024-1655	1
COVER-GENERATOR (Ref # 14031)	14031-1223	1
COVER-CLUTCH (Ref # 14032)	14032-1259	1
CAP-OIL FILLER (Ref # 16115)	16115-1009	1
GAUGE,OIL LEVEL (Ref # 52005)	52005-1009	1
WASHER,25.3X33X1 (Ref # 92022)	92022-1109	1
BUSHING (Ref # 92028)	92028-1544	1
PIN,6.2X8X14 (Ref # 92043)	92043-1263	4
SEAL-OIL,SCY 15X30X7 (Ref # 92049)	92049-1158	1
SEAL-OIL,TC25356 (Ref # 92049A)	92049-1317	1
RING-O,31.5X2.6 (Ref # 92055)	92055-049	1
RING-O (Ref # 92055A)	92055-1146	1
RING-O,63.6X2.4 (Ref # 92055B)	92055-1433	1
PLUG,COVER (Ref # 92066)	92066-1163	1
CLAMP (Ref # 92170)	92170-1065	1