

# 1992 Bayou 300 4X4 PARTS DIAGRAM

Front Bevel Gear

E3131

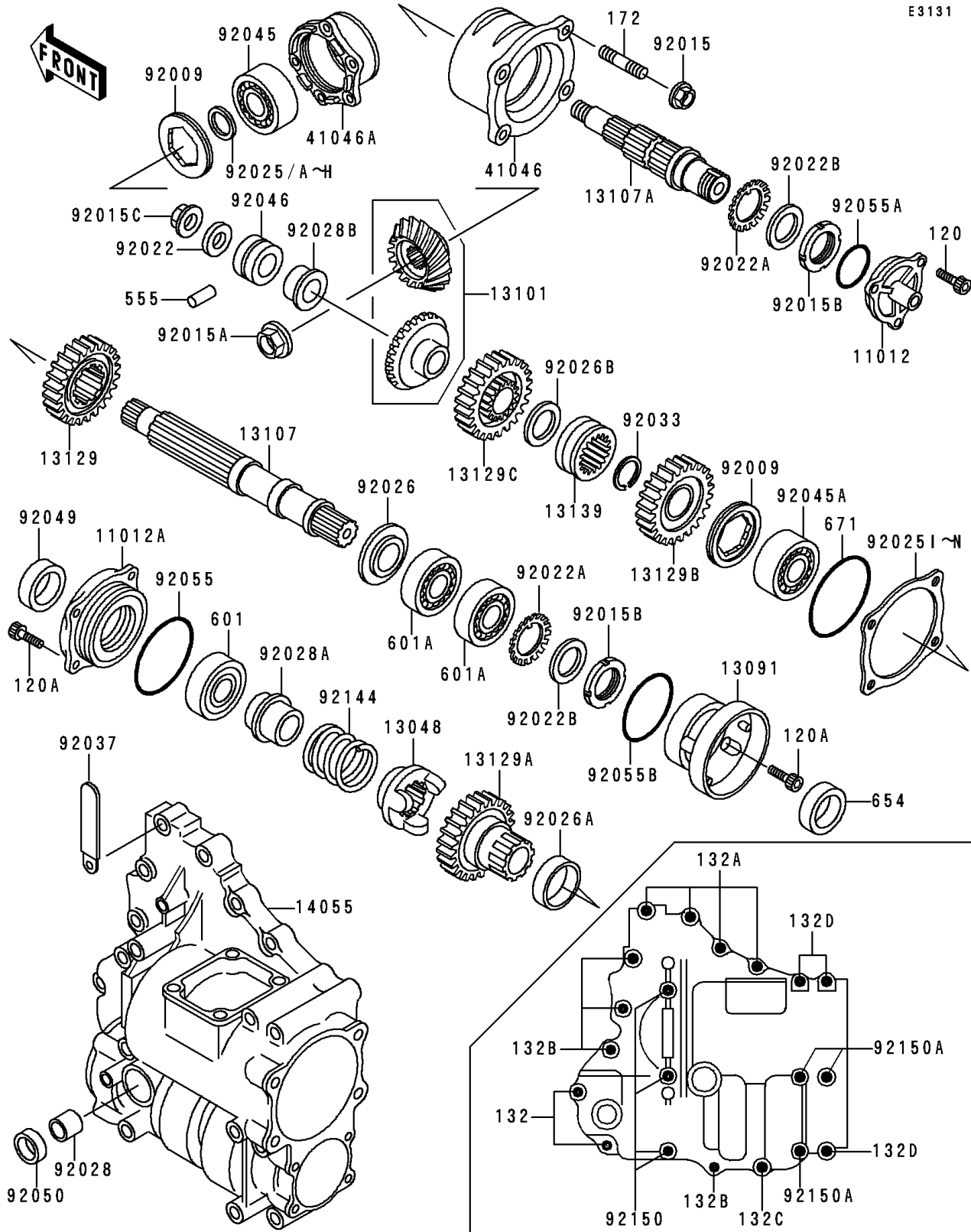

# 1992 Bayou 300 4X4 PARTS LIST

## Front Bevel Gear

ITEM NAME	PART NUMBER	QUANTITY
CAP (Ref # 11012)	11012-1641	1
CAP (Ref # 11012A)	11012-1642	1
CAM-DAMPER (Ref # 13048)	13048-1075	1
HOLDER (Ref # 13091)	13091-1542	1
GEAR-ASSY,BEVEL (Ref # 13101)	13101-5078	1
SHAFT (Ref # 13107)	13107-1227	1
SHAFT (Ref # 13107A)	13107-1228	1
GEAR-TRANSMISSION SPUR,37T (Ref # 13129)	13129-1948	1
GEAR-TRANSMISSION SPUR,33T (Ref # 13129A)	13129-1949	1
GEAR-TRANSMISSION SPUR (Ref # 13129B)	13129-1950	1
GEAR-TRANSMISSION SPUR (Ref # 13129C)	13129-1951	1
SHIFTER (Ref # 13139)	13139-1056	1
CASE-GEAR (Ref # 14055)	14055-1086	1
HOUSING-BEARING (Ref # 41046)	41046-1088	1
HOUSING-BEARING,GEAR CASE,FR (Ref # 41046A)	41046-1098	1
SCREW,55MM (Ref # 92009)	92009-1384	2
NUT,8MM (Ref # 92015)	92015-1402	4
NUT (Ref # 92015A)	92015-1581	1
NUT,25MM (Ref # 92015B)	92015-1768	2
NUT,FLANGED,12MM (Ref # 92015C)	92015-1911	1
WASHER,12X24X2.3 (Ref # 92022)	92022-1890	1
WASHER,TOOTHED (Ref # 92022A)	92022-1990	2
WASHER,25.3X32X0.5 (Ref # 92022B)	92022-225	2
SHIM,20.3X28X1.3 (Ref # 92025)	92025-1533	AR
SHIM,20.3X28X0.7 (Ref # 92025A)	92025-1534	AR
SHIM,20.3X28X0.8 (Ref # 92025B)	92025-1535	AR
SHIM,20.3X28X0.9 (Ref # 92025C)	92025-1536	AR
SHIM,20.3X28X1.0 (Ref # 92025D)	92025-1537	AR
SHIM,20.3X28X1.2 (Ref # 92025E)	92025-1538	AR

# 1992 Bayou 300 4X4 PARTS LIST

## Front Bevel Gear

ITEM NAME	PART NUMBER	QUANTITY
SHIM,20.3X28X0.15 (Ref # 92025F)	92025-1573	AR
SHIM,20.3X28X0.20 (Ref # 92025G)	92025-1574	AR
SHIM,20.3X28X1.1 (Ref # 92025H)	92025-1575	AR
SHIM,T=0.10 (Ref # 92025I)	92025-1897	AR
SHIM,T=0.15 (Ref # 92025J)	92025-1898	AR
SHIM,T=0.50 (Ref # 92025K)	92025-1899	AR
SHIM,T=0.80 (Ref # 92025L)	92025-1900	AR
SHIM,T=1.00 (Ref # 92025M)	92025-1901	AR
SHIM,T=1.20 (Ref # 92025N)	92025-1902	AR
SPACER (Ref # 92026)	92026-1334	1
SPACER,40X44X16 (Ref # 92026A)	92026-1335	1
BOLT-SOCKET,6X14 (Ref # 120)	120P0614	3
BOLT-SOCKET,6X20 (Ref # 120A)	120P0620	8
BOLT-FLANGED-SMALL (Ref # 132)	132J0625	2
BOLT-FLANGED-SMALL (Ref # 132A)	132J0630	4
BOLT-FLANGED-SMALL (Ref # 132B)	132J0635	4
BOLT-FLANGED-SMALL (Ref # 132C)	132J0675	1
BOLT-FLANGED-SMALL (Ref # 132D)	132J0895	3
BOLT-STUD,8X22 (Ref # 172)	172G0822	4
PIN-SPRING (Ref # 555)	555A0432	1
BEARING-BALL (Ref # 601)	601B6007	1
BEARING-BALL,#6205C3 (Ref # 601A)	601B6205	2
OIL SEAL,30X42X8 (Ref # 654)	654A304208	1
O RING (Ref # 671)	671B2575	1
SPACER,24.5X36X2.0 (Ref # 92026B)	92026-1336	1
BUSHING (Ref # 92028)	92028-1347	1
BUSHING (Ref # 92028A)	92028-1539	1
BUSHING (Ref # 92028B)	92028-1540	1
RING-SNAP,28.6MM (Ref # 92033)	92033-1248	1

## 1992 Bayou 300 4X4 PARTS LIST

### Front Bevel Gear

ITEM NAME	PART NUMBER	QUANTITY
CLAMP (Ref # 92037)	92037-1679	1
BEARING-BALL,5304 (Ref # 92045)	92045-1144	1
BEARING-BALL,5205 (Ref # 92045A)	92045-1221	1
BEARING-NEEDLE,RNA4904RE (Ref # 92046)	92046-1182	1
SEAL-OIL (Ref # 92049)	92049-1047	1
SEAL-OIL (Ref # 92050)	92050-082	2
RING-O,ID=57.6 (Ref # 92055)	92055-1038	1
RING-O,40.2X2.4 (Ref # 92055A)	92055-1405	1
RING-O,47.2X2.4 (Ref # 92055B)	92055-1406	1
SPRING (Ref # 92144)	92144-1273	1
BOLT,8X85 (Ref # 92150)	92150-1104	3
BOLT,8X110 (Ref # 92150A)	92150-1105	3