

1999 Bayou 300 4X4 PARTS DIAGRAM

Clutch

E1350

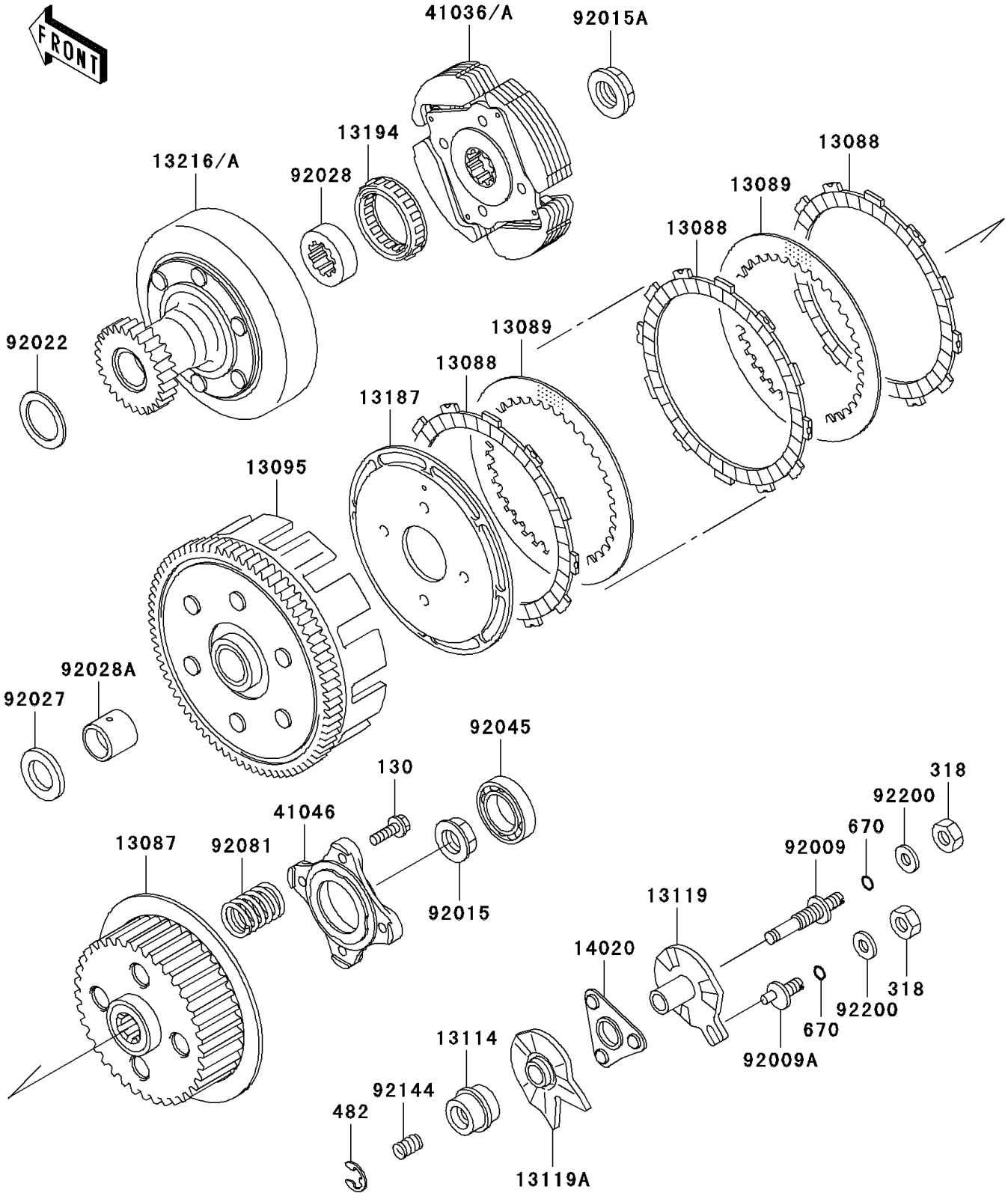

1999 Bayou 300 4X4 PARTS LIST

Clutch

ITEM NAME	PART NUMBER	QUANTITY
BOLT-FLANGED,6X20 (Ref # 130)	130P0620	4
NUT-HEX-SMALL,8MM (Ref # 318)	318B0800	2
CIRCLIP-TYPE-E,7MM (Ref # 482)	482J7000	1
O RING,8MM (Ref # 670)	670B1508	2
HUB-CLUTCH (Ref # 13087)	13087-1065	1
PLATE-FRICTION (Ref # 13088)	13088-041	5
PLATE-CLUTCH (Ref # 13089)	13089-1005	4
HOUSING-COMP-CLUTCH (Ref # 13095)	13095-1364	1
PUSHER-CLUTCH (Ref # 13114)	13114-1060	1
CAM-RELEASE (Ref # 13119)	13119-1067	1
CAM-RELEASE (Ref # 13119A)	13119-1070	1
PLATE-CLUTCH OPERATING (Ref # 13187)	13187-1081	1
CLUTCH-ONEWAY (Ref # 13194)	13194-1055	1
GEAR-COMP,CLUTCH,FR (Ref # 13216)	13216-1073	1
RETAINER,CLUTCH RELEASE (Ref # 14020)	14020-1092	1
HUB-ASSY,CLUTCH,FR (Ref # 41036)	41036-1122	1
HOUSING-BEARING (Ref # 41046)	41046-1063	1
SCREW (Ref # 92009)	92009-1525	1
SCREW (Ref # 92009A)	92009-1526	1
NUT,16MM (Ref # 92015)	92015-1465	1
NUT,18MM (Ref # 92015A)	92015-1512	1
WASHER,27.3X38X0.8 (Ref # 92022)	92022-1989	1
COLLAR,20.5X34X4 (Ref # 92027)	92027-1888	1
BUSHING,CLUTCH,FR (Ref # 92028)	92028-1370	1
BUSHING,CLUTCH (Ref # 92028A)	92028-1371	1
BEARING-BALL,#6905 (Ref # 92045)	92045-036	1
SPRING,CLUTCH (Ref # 92081)	92081-1848	4
SPRING (Ref # 92144)	92144-1272	1
WASHER,8.5X18X2.3 (Ref # 92200)	92200-1213	2