

2001 Bayou 300 4X4 PARTS DIAGRAM

Drive Shaft(Rear)

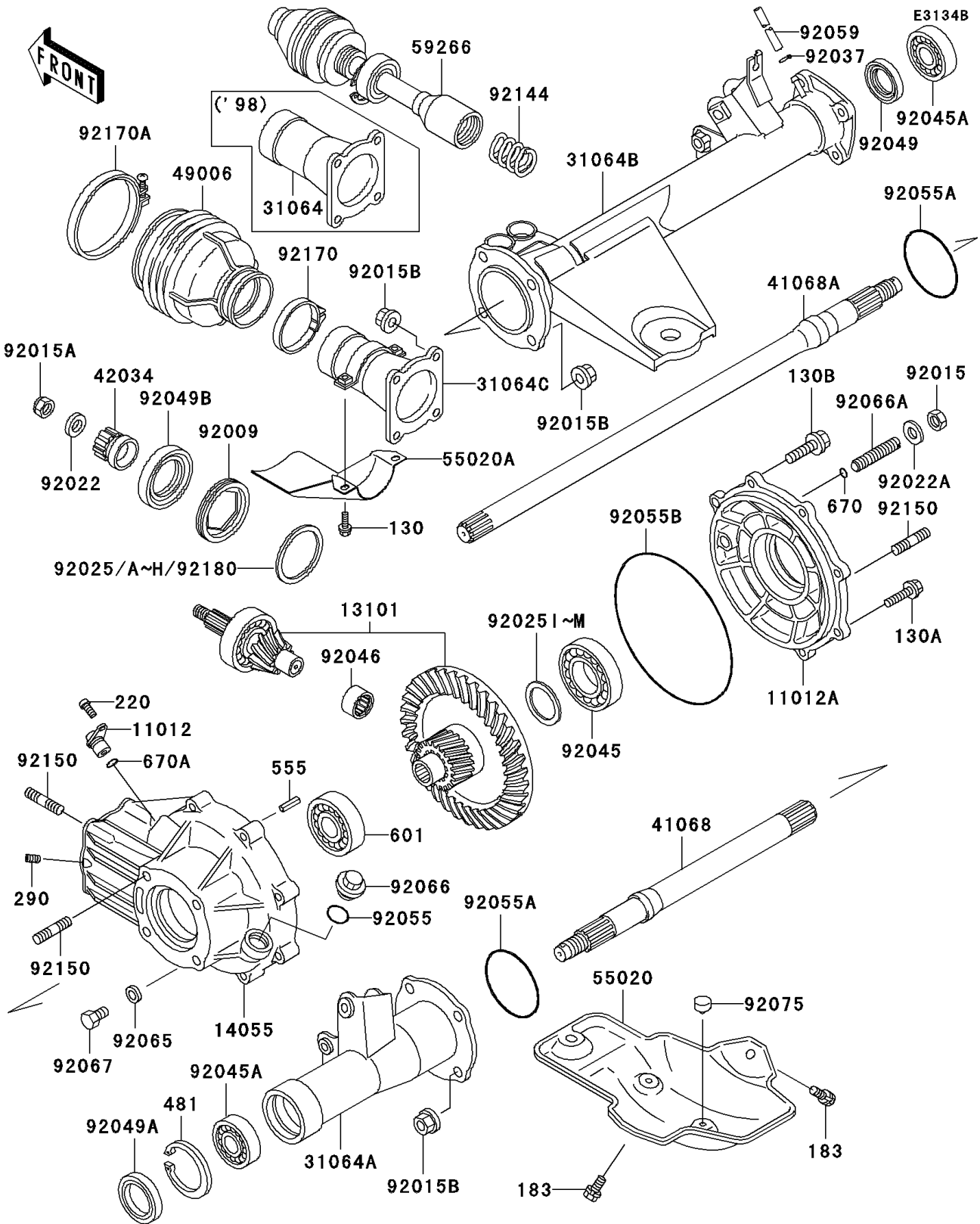

2001 Bayou 300 4X4 PARTS LIST

Drive Shaft(Rear)

ITEM NAME	PART NUMBER	QUANTITY
CAP,METER GEAR (Ref # 11012)	11012-1650	1
CAP,GEAR CASE (Ref # 11012A)	11012-1651	1
GEAR-ASSY,BEVEL (Ref # 13101)	13101-5084	1
CASE-GEAR,RR (Ref # 14055)	14055-1089	1
PIPE-COMP,LH (Ref # 31064A)	31064-1098	1
PIPE-COMP,RH (Ref # 31064B)	31064-1099	1
PIPE-COMP (Ref # 31064C)	31064-1218	1
AXLE,LH (Ref # 41068)	41068-1347	1
AXLE,RH (Ref # 41068A)	41068-1348	1
COUPLING (Ref # 42034)	42034-1104	1
BOOT,DRIVE SHAFT (Ref # 49006)	49006-1237	1
GUARD,ENGINE (Ref # 55020)	55020-1306	1
GUARD (Ref # 55020A)	55020-1675	1
JOINT-BALL (Ref # 59266)	59266-1099	1
SCREW (Ref # 92009)	92009-1528	1
NUT,12MM (Ref # 92015)	92015-006	1
NUT,12MM (Ref # 92015A)	92015-1182	1
NUT,FLANGED,10MM (Ref # 92015B)	92015-1335	12
WASHER,12.3X25X3.2 (Ref # 92022)	92022-1293	1
WASHER,12MM (Ref # 92022A)	92022-1538	1
SHIM,52.5X61.5X0.15 (Ref # 92025)	92025-1669	AR
SHIM,52.5X61.5X0.18 (Ref # 92025A)	92025-1670	AR
SHIM,52.5X61.5X0.8 (Ref # 92025B)	92025-1671	AR
SHIM,52.5X61.5X0.9 (Ref # 92025C)	92025-1672	AR
SHIM,52.5X61.5X1.0 (Ref # 92025D)	92025-1673	AR
SHIM,52.5X61.5X1.1 (Ref # 92025E)	92025-1674	AR
SHIM,52.5X61.5X1.2 (Ref # 92025F)	92025-1675	AR
SHIM,52.5X61.5X1.3 (Ref # 92025G)	92025-1676	AR
SHIM,52.5X61.5X1.4 (Ref # 92025H)	92025-1677	AR

2001 Bayou 300 4X4 PARTS LIST

Drive Shaft(Rear)

ITEM NAME	PART NUMBER	QUANTITY
SHIM,35.3X46X1.00 (Ref # 92025I)	92025-1849	AR
SHIM,35.3X46X0.10 (Ref # 92025J)	92025-1850	AR
SHIM,35.3X46X0.15 (Ref # 92025K)	92025-1851	AR
SHIM,35.3X46X0.50 (Ref # 92025L)	92025-1856	AR
SHIM,35.3X46X0.80 (Ref # 92025M)	92025-1857	AR
CLAMP,TUBE (Ref # 92037)	92037-147	1
BEARING-BALL (Ref # 92045)	92045-1110	1
BEARING-BALL,6205DDU (Ref # 92045A)	92045-1229	2
BEARING-NEEDLE,NK20/16RE (Ref # 92046)	92046-1183	1
SEAL-OIL,SO30428 (Ref # 92049)	92049-1236	1
BOLT-FLANGED (Ref # 130)	130J0612	2
BOLT-FLANGED,8X30 (Ref # 130A)	130P0830	6
BOLT-FLANGED (Ref # 130B)	130P1035	2
BOLT-UPSET-WS-SMALL (Ref # 183)	183H0814	3
SCREW-PAN-CROS (Ref # 220)	220X0614	1
SCREW-SET-SOCKET (Ref # 290)	290Q0612	1
CIRCLIP (Ref # 481)	481J5200	1
PIN-SPRING (Ref # 555)	555A0422	1
BEARING-BALL,#6007C3 (Ref # 601)	601B6007	1
O RING,9MM (Ref # 670)	670B1509	1
O RING,12MM (Ref # 670A)	670B2012	1
SEAL-OIL (Ref # 92049A)	92049-1287	1
SEAL-OIL,TC406510 (Ref # 92049B)	92049-1310	1
RING-O,25.7X2.4 (Ref # 92055)	92055-1136	1
RING-O (Ref # 92055A)	92055-1207	2
RING-O,164.1X2.5 (Ref # 92055B)	92055-1411	1
TUBE,4.7X9.5X1240 (Ref # 92059)	92059-1968	1
GASKET,10.5X16X1 (Ref # 92065)	92065-058	1
PLUG (Ref # 92066)	92066-1303	1

2001 Bayou 300 4X4 PARTS LIST

Drive Shaft(Rear)

ITEM NAME	PART NUMBER	QUANTITY
PLUG (Ref # 92066A)	92066-1305	1
PLUG,DRAIN,10X12 (Ref # 92067)	92067-001	1
DAMPER (Ref # 92075)	92075-021	3
SPRING (Ref # 92144)	92144-1278	1
BOLT,10X22 (Ref # 92150)	92150-1197	12
CLAMP (Ref # 92170)	92170-1674	1
CLAMP (Ref # 92170A)	92170-1676	1
SHIM,52.5X61.5X0.10 (Ref # 92180)	92180-1115	AR