

1999 Bayou 300 4X4 PARTS DIAGRAM

Control

E7110

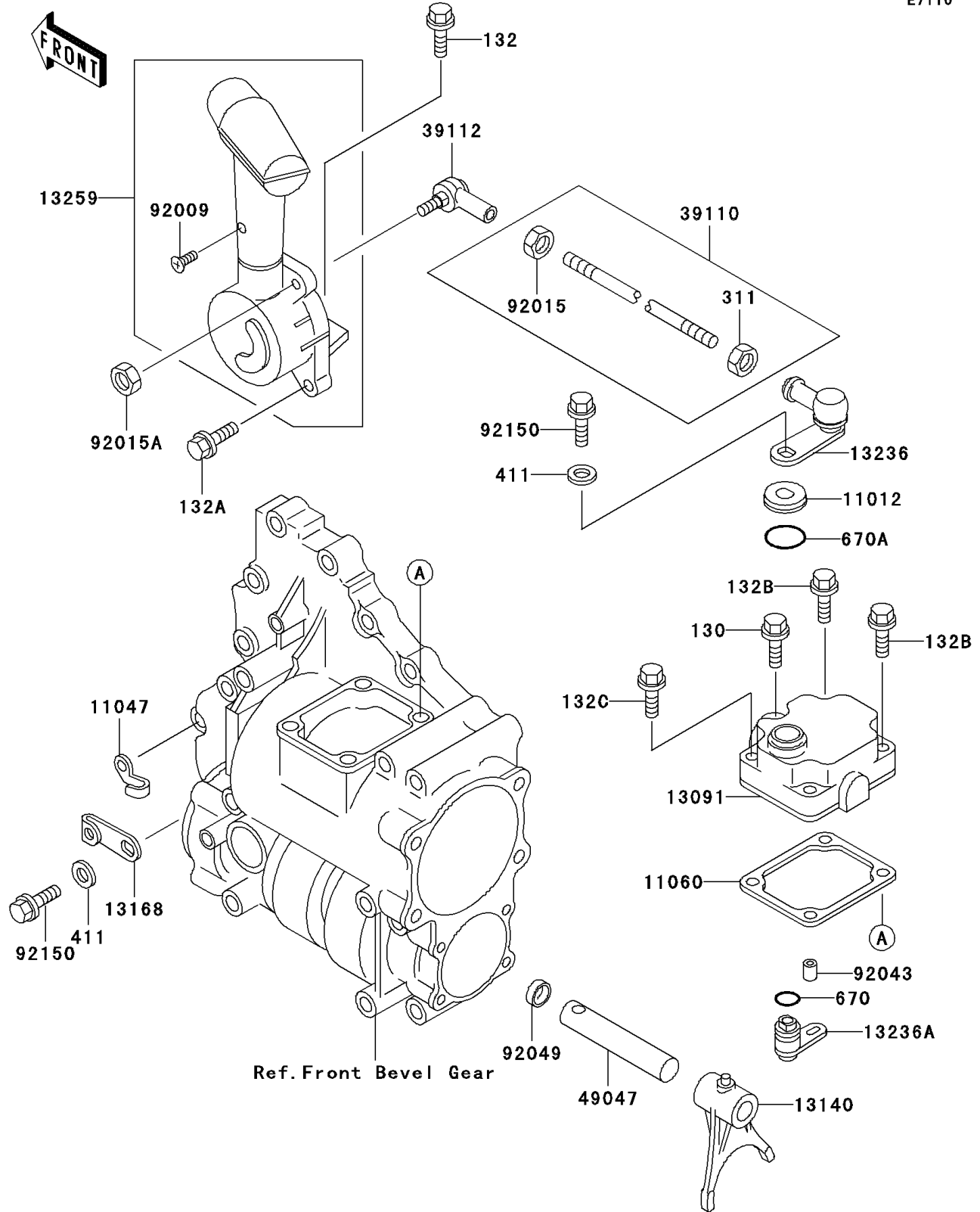

1999 Bayou 300 4X4 PARTS LIST

Control

ITEM NAME	PART NUMBER	QUANTITY
BOLT-FLANGED (Ref # 130)	130J0620	1
BOLT-FLANGED-SMALL (Ref # 132)	132J0620	1
BOLT-FLANGED-SMALL (Ref # 132A)	132J0625	2
BOLT-FLANGED-SMALL (Ref # 132B)	132J0630	2
BOLT-FLANGED-SMALL,6X40 (Ref # 132C)	132J0640	2
NUT-HEX (Ref # 311)	311J0600	1
WASHER-PLAIN,6MM,BLACK (Ref # 411)	411F0600	2
O RING,10MM (Ref # 670)	670B2010	1
O RING,18MM (Ref # 670A)	670B2018	1
CAP (Ref # 11012)	11012-1652	1
BRACKET,RELEASE LOCK WIRE (Ref # 11047)	11047-1440	1
GASKET,CONTROL LEVER (Ref # 11060)	11060-1718	1
HOLDER (Ref # 13091)	13091-1548	1
FORK-SHIFT (Ref # 13140)	13140-1175	1
LEVER,RELEASE LOCK (Ref # 13168)	13168-1395	1
LEVER-COMP (Ref # 13236)	13236-1175	1
LEVER-COMP (Ref # 13236A)	13236-1176	1
LEVER-ASSY-SHIFT CONTROL (Ref # 13259)	13259-1003	1
ROD-ASSY-TIE (Ref # 39110)	39110-1087	1
RODEND-TIE (Ref # 39112)	39112-1006	1
ROD-SHIFT (Ref # 49047)	49047-1078	1
SCREW,4X8 (Ref # 92009)	92009-1554	4
NUT (Ref # 92015)	92015-1178	1
NUT,LOCK,6MM,BLACK (Ref # 92015A)	92015-1191	1
PIN,6.2X8X14 (Ref # 92043)	92043-1263	2
SEAL-OIL,RCA124 (Ref # 92049)	92049-1311	1
BOLT (Ref # 92150)	92150-1681	2