

# 1999 Bayou 300 4X4 PARTS DIAGRAM

Rear Fender(s)

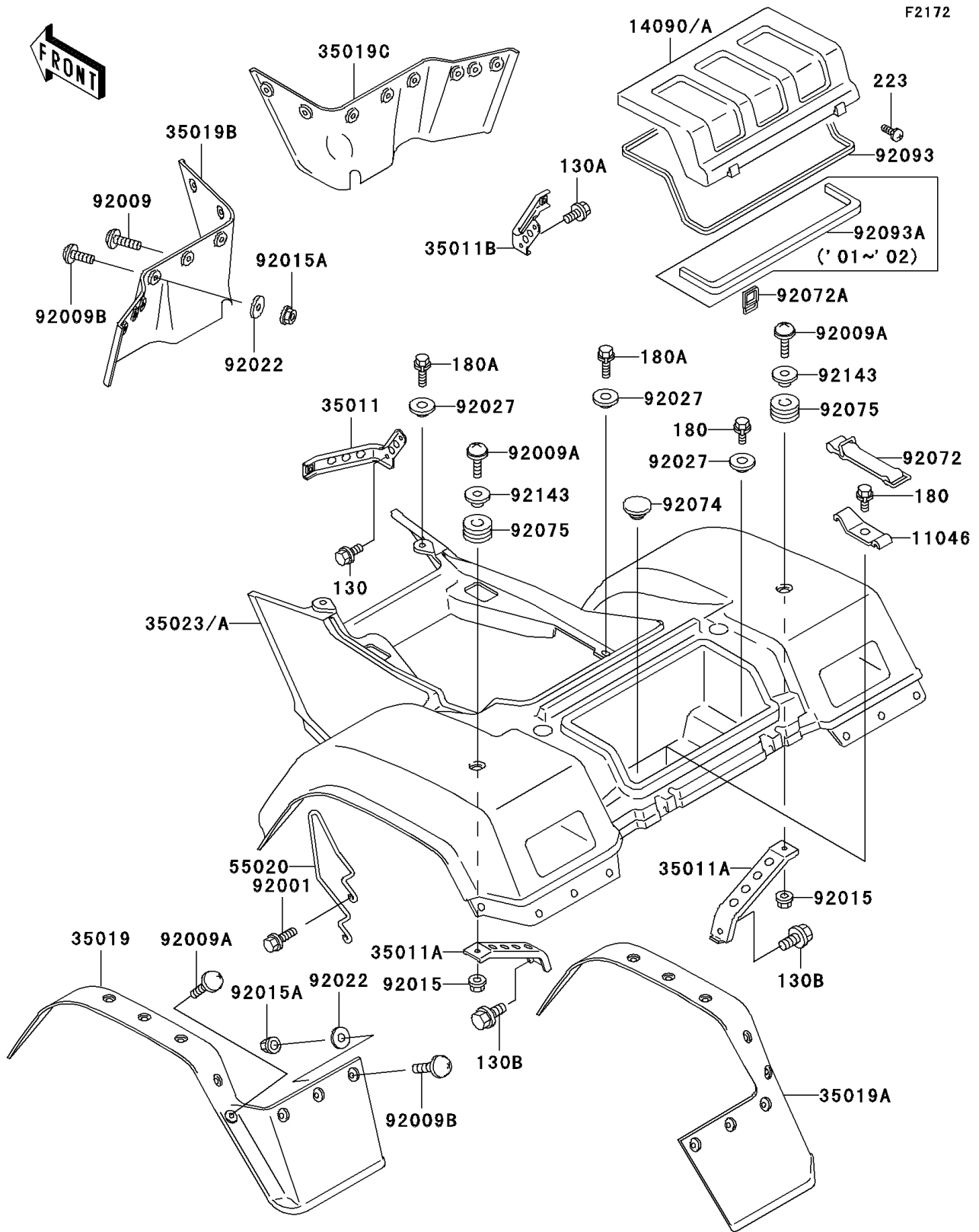

# 1999 Bayou 300 4X4 PARTS LIST

## Rear Fender(s)

ITEM NAME	PART NUMBER	QUANTITY
BOLT-FLANGED,6X10 (Ref # 130)	130B0610	2
BOLT-FLANGED,6X12 (Ref # 130A)	130B0612	2
BOLT-FLANGED,8X12 (Ref # 130B)	130B0812	2
BOLT-UPSET-WS (Ref # 180)	180D0614	2
BOLT-UPSET-WS (Ref # 180A)	180D0618	4
SCREW-PAN-WS-CROS,4X6 (Ref # 223)	223C0406	2
BRACKET,BAND (Ref # 11046)	11046-1319	1
COVER,REAR FENDER,H.GREEN (Ref # 14090)	14090-1160-6A	1
COVER,REAR FENDER,F.RED (Ref # 14090A)	14090-1160-6L	1
STAY,REAR FENDER,FR,LH (Ref # 35011)	35011-1423	1
STAY,REAR FENDER,UPP (Ref # 35011A)	35011-1424	2
STAY,REAR FENDER,FR,RH (Ref # 35011B)	35011-1440	1
FLAP,RR,LH,BLACK (Ref # 35019)	35019-1298-6Z	1
FLAP,RR,RH,BLACK (Ref # 35019A)	35019-1299-6Z	1
FLAP,RR,LWR,LH,F.BLACK (Ref # 35019B)	35019-1325-6Z	1
FLAP,RR,LWR,RH,F.BLACK (Ref # 35019C)	35019-1326-6Z	1
FENDER-REAR,H.GREEN (Ref # 35023)	35023-1332-6A	1
FENDER-REAR,F.C.RED (Ref # 35023A)	35023-1332-6L	1
GUARD (Ref # 55020)	55020-1322	1
BOLT,6X18 (Ref # 92001)	92001-1342	2
SCREW,6X18,BLACK (Ref # 92009)	92009-1181	2
SCREW,6X22,BLACK (Ref # 92009A)	92009-1256	4
SCREW,6X16 (Ref # 92009B)	92009-1621	34
NUT,FLANGED,6MM,BLACK (Ref # 92015)	92015-1233	2
NUT,LOCK,FLANGED,6MM (Ref # 92015A)	92015-1675	36
WASHER,6.5X16X1.0 (Ref # 92022)	92022-1093	36
COLLAR,L=4.7 (Ref # 92027)	92027-1964	5
BAND (Ref # 92072)	92072-1085	1
BAND,REAR FENDER COVER (Ref # 92072A)	92072-1291	2

# 1999 Bayou 300 4X4 PARTS LIST

Rear Fender(s)

ITEM NAME	PART NUMBER	QUANTITY
PLUG,11X3.2 (Ref # 92074)	92074-038	1
DAMPER,CASE (Ref # 92075)	92075-222	2
SEAL,REAR FENDER COVER (Ref # 92093)	92093-1262	1
COLLAR,L=9.6 (Ref # 92143)	92143-1016	2