

# 1999 Bayou 400 4X4 PARTS DIAGRAM

Front Bevel Gear

E3131

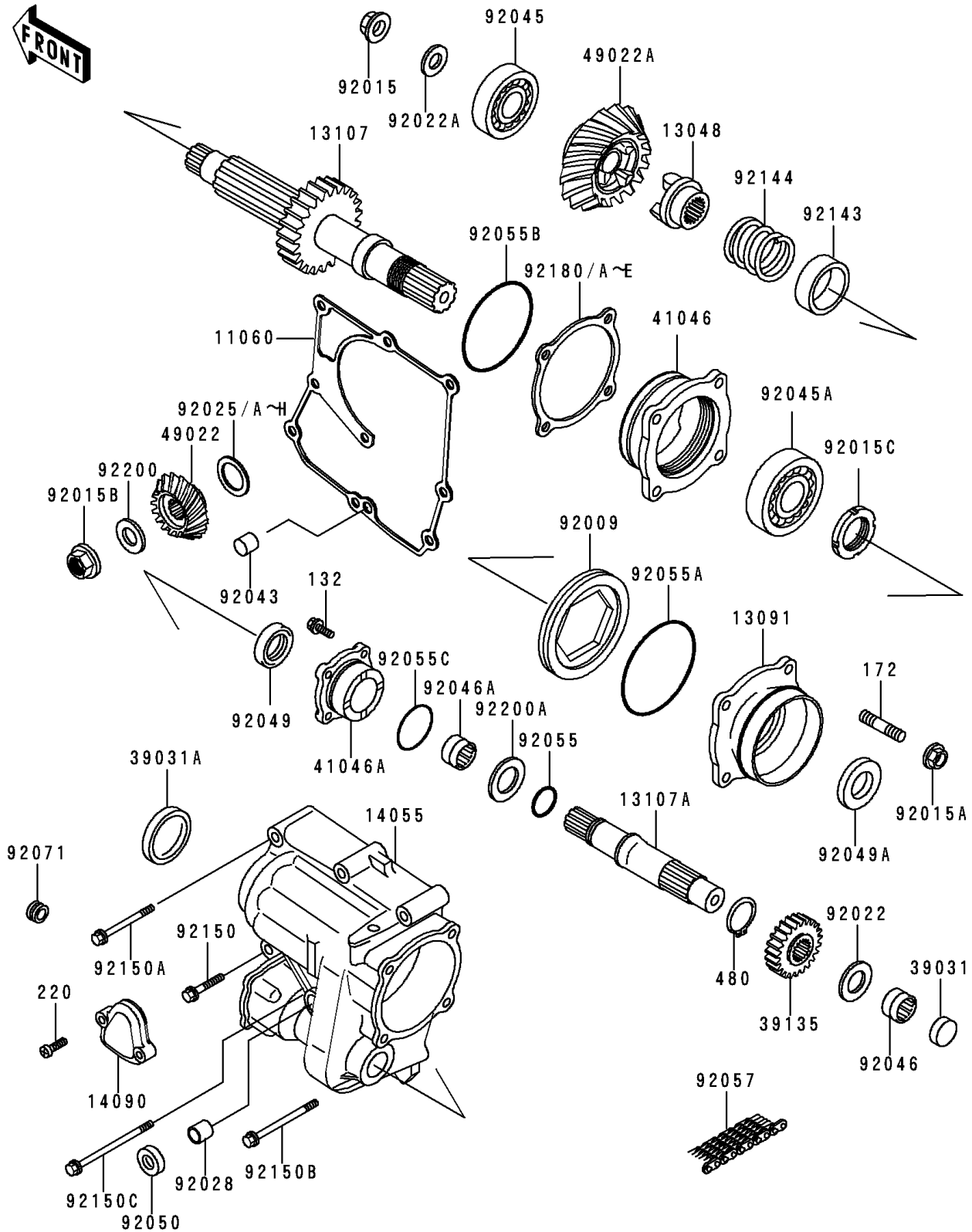

# 1999 Bayou 400 4X4 PARTS LIST

## Front Bevel Gear

ITEM NAME	PART NUMBER	QUANTITY
GASKET,GEAR CASE (Ref # 11060)	11060-1708	1
CAM-DAMPER (Ref # 13048)	13048-1078	1
HOLDER,GEAR CASE (Ref # 13091)	13091-1764	1
SHAFT,FRONT BEVEL,23T (Ref # 13107)	13107-1323	1
SHAFT,FRONT BEVEL (Ref # 13107A)	13107-1332	1
CASE-GEAR,FRONT BEVEL (Ref # 14055)	14055-1122	1
COVER (Ref # 14090)	14090-1135	1
CAP-END (Ref # 39031)	39031-1061	1
CAP-END (Ref # 39031A)	39031-1062	1
SPROCKET-DRIVEN,23T (Ref # 39135)	39135-1054	1
HOUSING-BEARING (Ref # 41046)	41046-1094	1
HOUSING-BEARING (Ref # 41046A)	41046-1095	1
GEAR-BEVEL (Ref # 49022)	49022-1126	1
GEAR-BEVEL (Ref # 49022A)	49022-1127	1
SCREW (Ref # 92009)	92009-1667	1
NUT,FLANGED,14MM (Ref # 92015)	92015-1341	1
NUT,8MM (Ref # 92015A)	92015-1402	4
NUT (Ref # 92015B)	92015-1581	1
NUT,30MM (Ref # 92015C)	92015-1858	1
WASHER,20.3X36X1.5 (Ref # 92022)	92022-1489	1
WASHER,14.2X28X2.6 (Ref # 92022A)	92022-1688	1
SHIM,25.3X36X0.15 (Ref # 92025)	92025-1688	AR
SHIM,25.3X36X0.50 (Ref # 92025A)	92025-1689	AR
SHIM,25.3X36X0.60 (Ref # 92025B)	92025-1690	AR
SHIM,25.3X36X0.70 (Ref # 92025C)	92025-1691	AR
SHIM,25.3X36X0.80 (Ref # 92025D)	92025-1692	AR
SHIM,25.3X36X0.90 (Ref # 92025E)	92025-1693	AR
SHIM,25.3X36X1.00 (Ref # 92025F)	92025-1694	AR
SHIM,25.3X36X1.10 (Ref # 92025G)	92025-1695	AR

# 1999 Bayou 400 4X4 PARTS LIST

## Front Bevel Gear

ITEM NAME	PART NUMBER	QUANTITY
SHIM,25.3X36X1.20 (Ref # 92025H)	92025-1696	AR
BUSHING (Ref # 92028)	92028-1347	1
PIN,DOWEL,10X14 (Ref # 92043)	92043-1037	1
BEARING-BALL,6206CM (Ref # 92045)	92045-1155	1
BEARING-BALL,6306SH2 (Ref # 92045A)	92045-1190	1
BEARING-NEEDLE,NK20/20RE (Ref # 92046)	92046-1211	1
BEARING-NEEDLE,NK24/20RE (Ref # 92046A)	92046-1212	1
SEAL-OIL,AE1252E0 (Ref # 92049)	92049-1395	1
SEAL-OIL,AE1265E0 (Ref # 92049A)	92049-1400	1
SEAL-OIL (Ref # 92050)	92050-082	2
RING-O,19.5X1.5 (Ref # 92055)	92055-055	1
BOLT-FLANGED-SMALL (Ref # 132)	132V0620	4
BOLT-STUD,8X25 (Ref # 172)	172G0825	4
SCREW-PAN-CROS,6X20,BLACK (Ref # 220)	220C0620	2
CIRCLIP-TYPE-C,25MM (Ref # 480)	480J2500	1
RING-O (Ref # 92055A)	92055-081	1
RING-O,79.5MM (Ref # 92055B)	92055-1230	1
RING-O,43.7X1.9 (Ref # 92055C)	92055-1401	1
CHAIN,BEVEL,63HV303-42AS (Ref # 92057)	92057-1351	1
GROMMET (Ref # 92071)	92071-1203	1
COLLAR,24.2X33X12 (Ref # 92143)	92143-1657	1
SPRING,BEVEL (Ref # 92144)	92144-1599	1
BOLT,8X35 (Ref # 92150)	92150-1585	2
BOLT,8X60 (Ref # 92150A)	92150-1586	3
BOLT,8X75 (Ref # 92150B)	92150-1587	3
BOLT,8X90 (Ref # 92150C)	92150-1588	1
SHIM,T=1.00 (Ref # 92180)	92180-1126	AR
SHIM,T=0.10 (Ref # 92180A)	92180-1127	AR
SHIM,T=0.15 (Ref # 92180B)	92180-1128	AR

# 1999 Bayou 400 4X4 PARTS LIST

## Front Bevel Gear

ITEM NAME	PART NUMBER	QUANTITY
SHIM,T=0.50 (Ref # 92180C)	92180-1129	AR
SHIM,T=0.80 (Ref # 92180D)	92180-1130	AR
SHIM,T=1.20 (Ref # 92180E)	92180-1131	AR
WASHER,16.3X31X3.2 (Ref # 92200)	92200-1104	1
WASHER,24.2X40X2.0 (Ref # 92200A)	92200-1118	1