

# 1999 Bayou 400 4X4 PARTS DIAGRAM

## Battery Case

F 2132

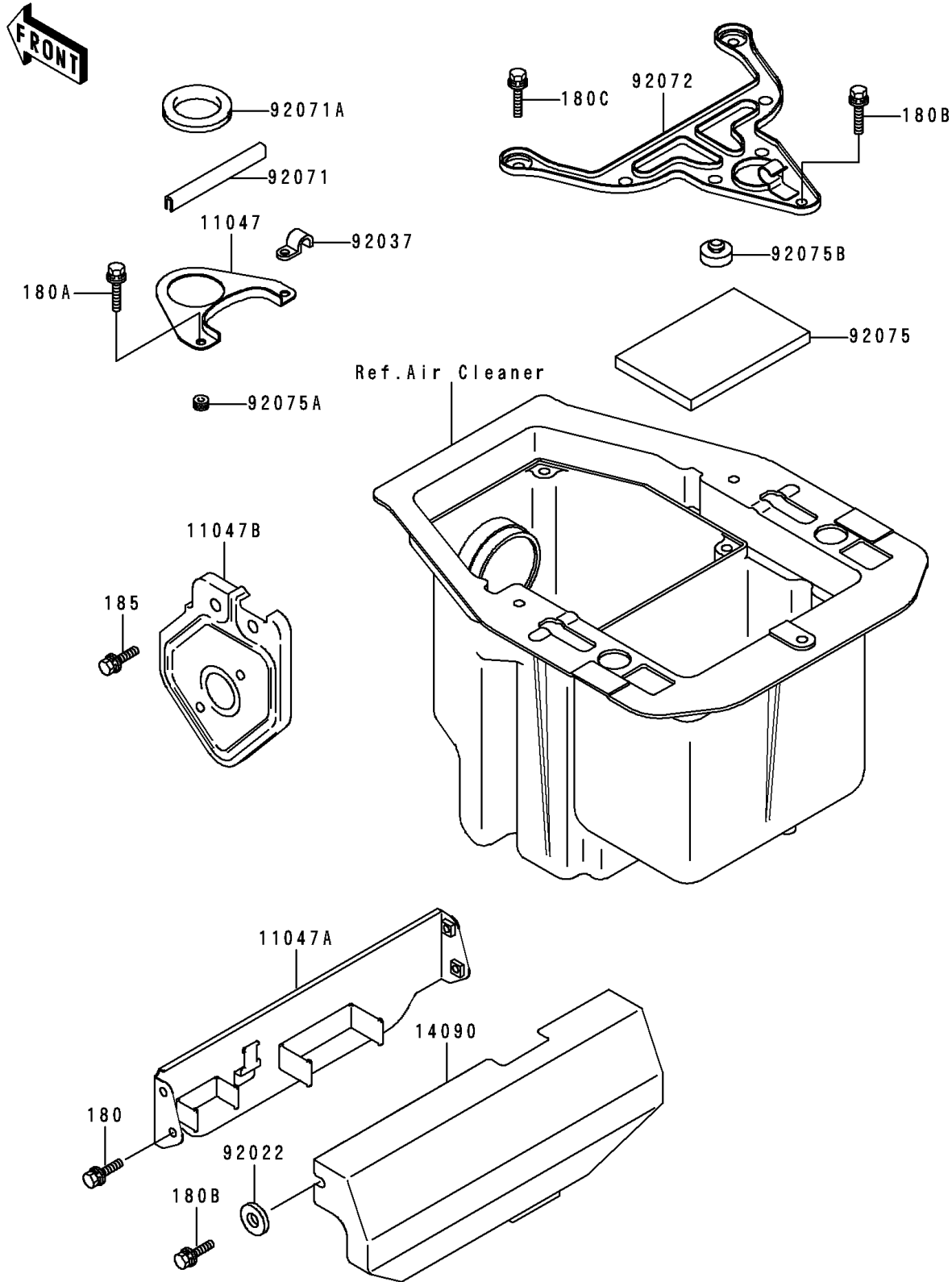

## 1999 Bayou 400 4X4 PARTS LIST

### Battery Case

ITEM NAME	PART NUMBER	QUANTITY
BOLT-UPSET-WS (Ref # 180)	180D0612	2
BOLT-UPSET-WS,6X14 (Ref # 180A)	180G0614	2
BOLT-UPSET-WS,6X16 (Ref # 180B)	180G0616	3
BOLT-UPSET-WS,6X20 (Ref # 180C)	180G0620	2
BOLT-UPSET-WSP-SMALL (Ref # 185)	185C0816	1
BRACKET,RESERVOIR TANK (Ref # 11047)	11047-1573	1
BRACKET,ELECTRIC BASE (Ref # 11047A)	11047-1579	1
BRACKET,REGULATOR (Ref # 11047B)	11047-1659	1
COVER,ELECTRIC (Ref # 14090)	14090-1154	1
WASHER,6.5X20X1.6,BLACK (Ref # 92022)	92022-1346	2
CLAMP (Ref # 92037)	92037-3730	1
GROMMET (Ref # 92071)	92071-1198	1
GROMMET (Ref # 92071A)	92071-3731	1
BAND,BATTERY (Ref # 92072)	92072-1289	1
DAMPER,BATTERY (Ref # 92075)	92075-1997	1
DAMPER,CASE (Ref # 92075A)	92075-222	2
DAMPER (Ref # 92075B)	92075-281	2