

1999 Bayou 400 4X4 PARTS DIAGRAM

Rear Fender(s)

F2172

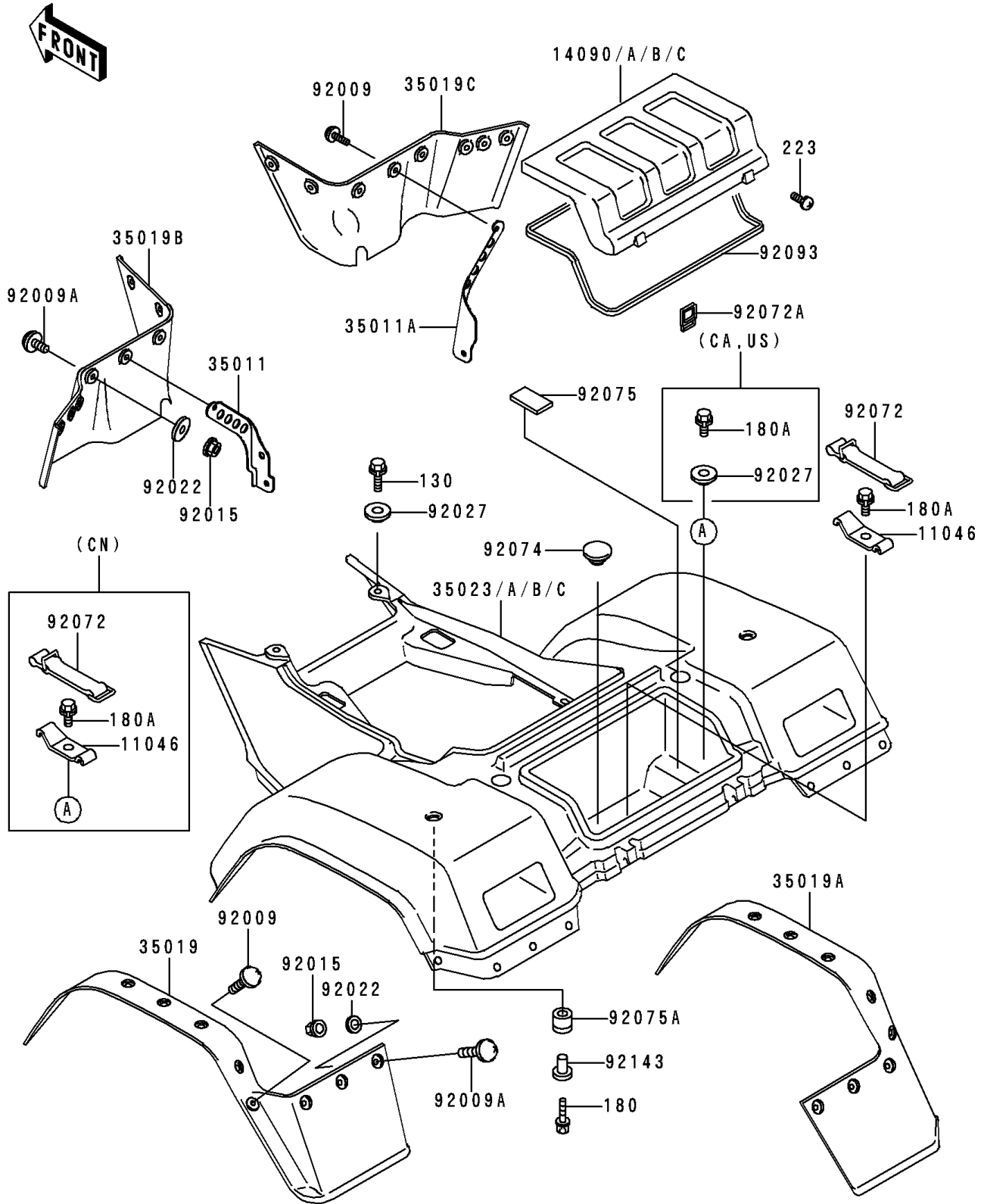

1999 Bayou 400 4X4 PARTS LIST

Rear Fender(s)

ITEM NAME	PART NUMBER	QUANTITY
BOLT-FLANGED (Ref # 130)	130C0618	2
BOLT-UPSET-WS,6X35 (Ref # 180)	180C0635	2
BOLT-UPSET-WS (Ref # 180A)	180D0614	2
SCREW-PAN-WS-CROS,4X6 (Ref # 223)	223C0406	2
COVER,REAR FENDER,H.GREEN (Ref # 14090A)	14090-1160-6A	1
STAY,RR FENDER,LH (Ref # 35011)	35011-1618	1
STAY,RR FENDER,RH (Ref # 35011A)	35011-1619	1
FLAP,RR,LH,BLACK (Ref # 35019)	35019-1298-6Z	1
FLAP,RR,RH,BLACK (Ref # 35019A)	35019-1299-6Z	1
FLAP,RR,LWR,LH,F.BLACK (Ref # 35019B)	35019-1325-6Z	1
FLAP,RR,LWR,RH,F.BLACK (Ref # 35019C)	35019-1326-6Z	1
FENDER-REAR,H.GREEN (Ref # 35023A)	35023-1332-6A	1
SCREW,6X22,BLACK (Ref # 92009)	92009-1256	4
SCREW,6X16 (Ref # 92009A)	92009-1621	34
NUT,LOCK,FLANGED,6MM (Ref # 92015)	92015-1675	40
WASHER,6.5X16X1.0 (Ref # 92022)	92022-1093	38
BAND,REAR FENDER COVER (Ref # 92072A)	92072-1291	2
PLUG,11X3.2 (Ref # 92074)	92074-038	1
DAMPER (Ref # 92075A)	92075-1936	2
SEAL,REAR FENDER COVER (Ref # 92093)	92093-1262	1
COLLAR,L=19.6 (Ref # 92143)	92143-1100	2
BRACKET,BAND (Ref # 11046)	11046-1319	2
BRACKET,BAND (Ref # 11046)	11046-1319	1
COLLAR,L=4.7 (Ref # 92027)	92027-122	2
COLLAR,L=4.7 (Ref # 92027)	92027-122	3
BAND (Ref # 92072)	92072-1085	2
BAND (Ref # 92072)	92072-1085	1
DAMPER (Ref # 92075)	92075-1830	1