

2003 KLX110 PARTS DIAGRAM

Gear Change Mechanism

E1370

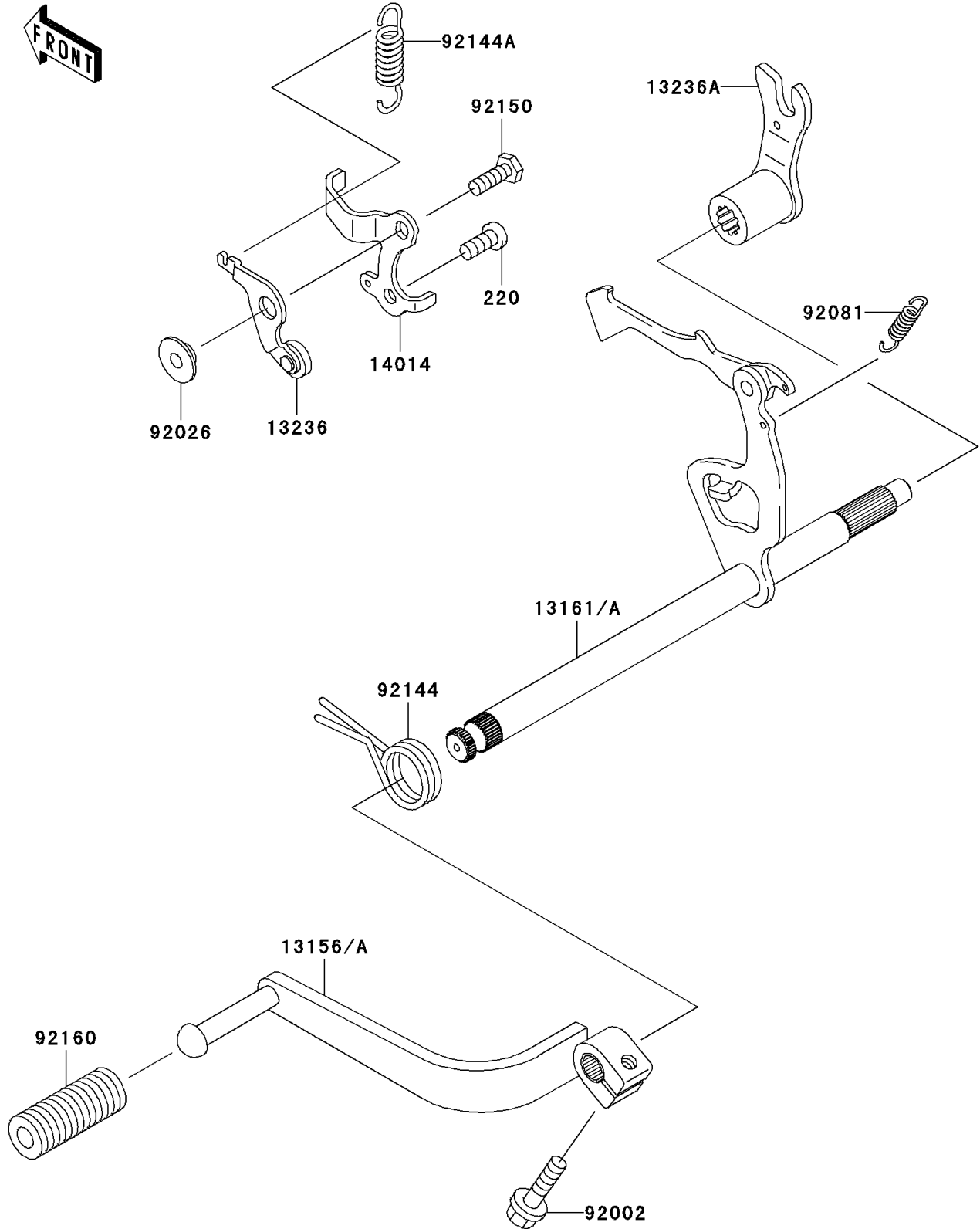

2003 KLX110 PARTS LIST

Gear Change Mechanism

ITEM NAME	PART NUMBER	QUANTITY
SCREW-PAN-CROS,6X14 (Ref # 220)	220B0614	1
LEVER-CHANGE,PEDAL (Ref # 13156A)	13156-1489	1
LEVER-COMP-CHANGE SHAFT (Ref # 13161)	13161-0003	1
LEVER-COMP,POSITION (Ref # 13236)	13236-1256	1
LEVER-COMP (Ref # 13236A)	13236-1288	1
PLATE-POSITION (Ref # 14014)	14014-1118	1
BOLT,6X20 (Ref # 92002)	92002-1237	1
SPACER (Ref # 92026)	92026-1217	1
SPRING,CHANGE LEVER (Ref # 92081)	92081-076	1
SPRING,CHANGE SHAFT RETURN (Ref # 92144)	92144-1107	1
SPRING (Ref # 92144A)	92144-1590	1
BOLT,6X14 (Ref # 92150)	92150-1626	1
DAMPER,CHANGE PEDAL (Ref # 92160)	92160-1036	1