

2005 KLX125 PARTS DIAGRAM

Swingarm(A2/A3)

F2141A

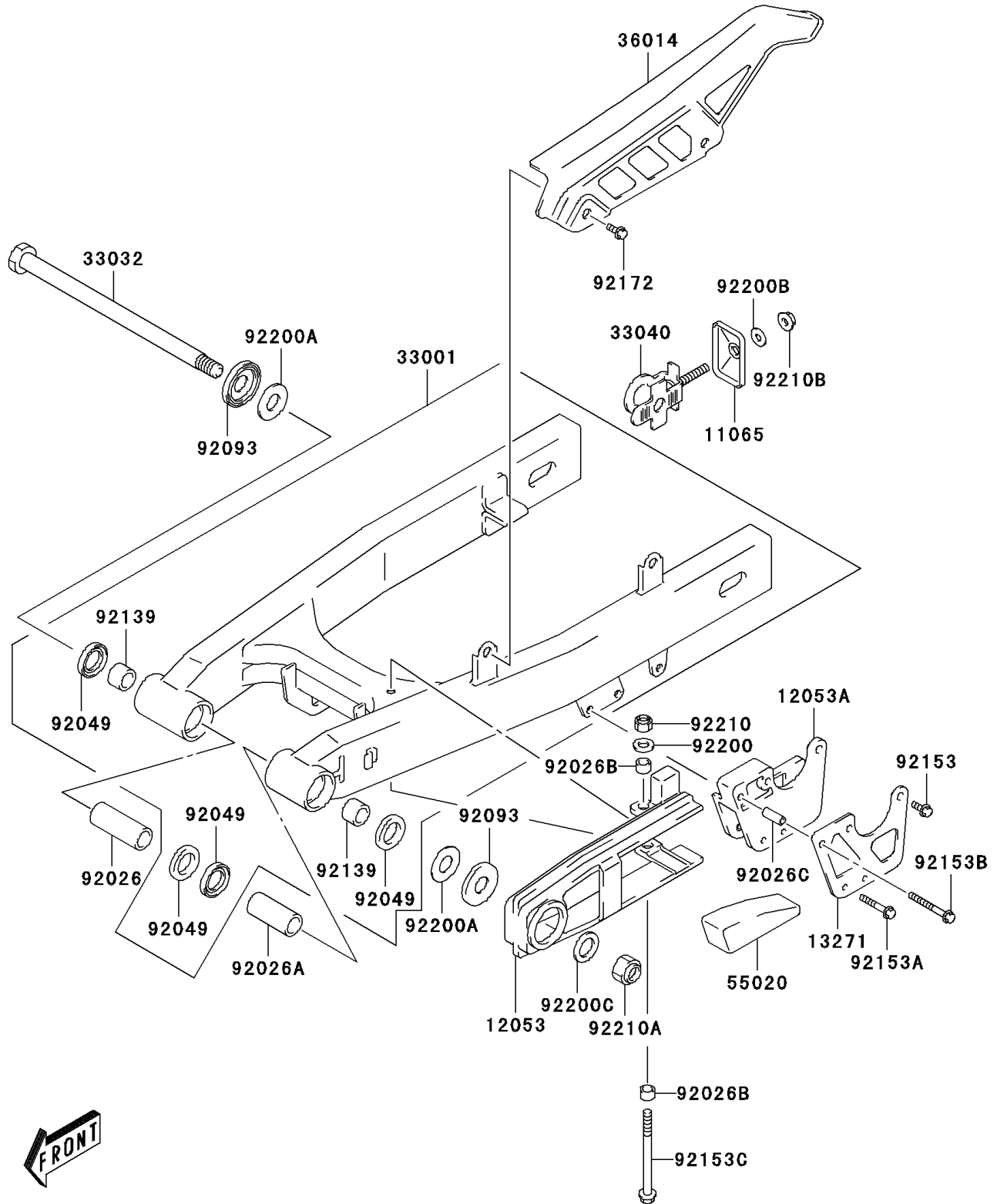

2005 KLX125 PARTS LIST

Swingarm(A2/A3)

ITEM NAME	PART NUMBER	QUANTITY
CAP,CHAIN ADJUSTER GUIDE (Ref # 11065)	11065-S018	2
GUIDE-CHAIN (Ref # 12053)	12053-S008	1
GUIDE-CHAIN,CHAIN (Ref # 12053A)	12053-S011	1
PLATE,CHAIN,GUIDE (Ref # 13271)	13271-S023	1
ARM-COMP-SWING,B.SILVER (Ref # 33001)	33001-S001-530	1
SHAFT-SWING ARM (Ref # 33032)	33032-S001	1
ADJUSTER-CHAIN (Ref # 33040)	33040-S001	2
CASE-CHAIN (Ref # 36014)	36014-S001	1
GUARD,CHAIN,GUIDE (Ref # 55020)	55020-S007	1
SPACER,SWING ARM PIVOT,RH (Ref # 92026)	92026-S042	1
SPACER,SWING ARM PIVOT,LH (Ref # 92026A)	92026-S043	1
SPACER,CHAIN (Ref # 92026B)	92026-S052	2
SPACER,CHAIN GUIDE (Ref # 92026C)	92026-S054	2
SEAL-OIL,SWINGARM (Ref # 92049)	92049-S022	4
SEAL,REAR SWINGARM (Ref # 92093)	92093-S012	2
BUSHING,REAR SWINGARM PIVOT (Ref # 92139)	92139-S008	2
BOLT (Ref # 92153)	92153-S177	1
BOLT (Ref # 92153A)	92153-S178	2
BOLT (Ref # 92153B)	92153-S179	2
BOLT (Ref # 92153C)	92153-S243	1
SCREW,6X10 (Ref # 92172)	92172-S099	2
WASHER (Ref # 92200)	92200-S003	1
WASHER (Ref # 92200A)	92200-S068	2
WASHER,12.5X26X2.3 (Ref # 92200B)	92200-S070	2
WASHER,14.5X24X2.3 (Ref # 92200C)	92200-S072	1
NUT (Ref # 92210)	92210-S024	1
NUT (Ref # 92210A)	92210-S057	1
NUT (Ref # 92210B)	92210-S094	2