

2006 KLX125 PARTS DIAGRAM

Cylinder

E1112

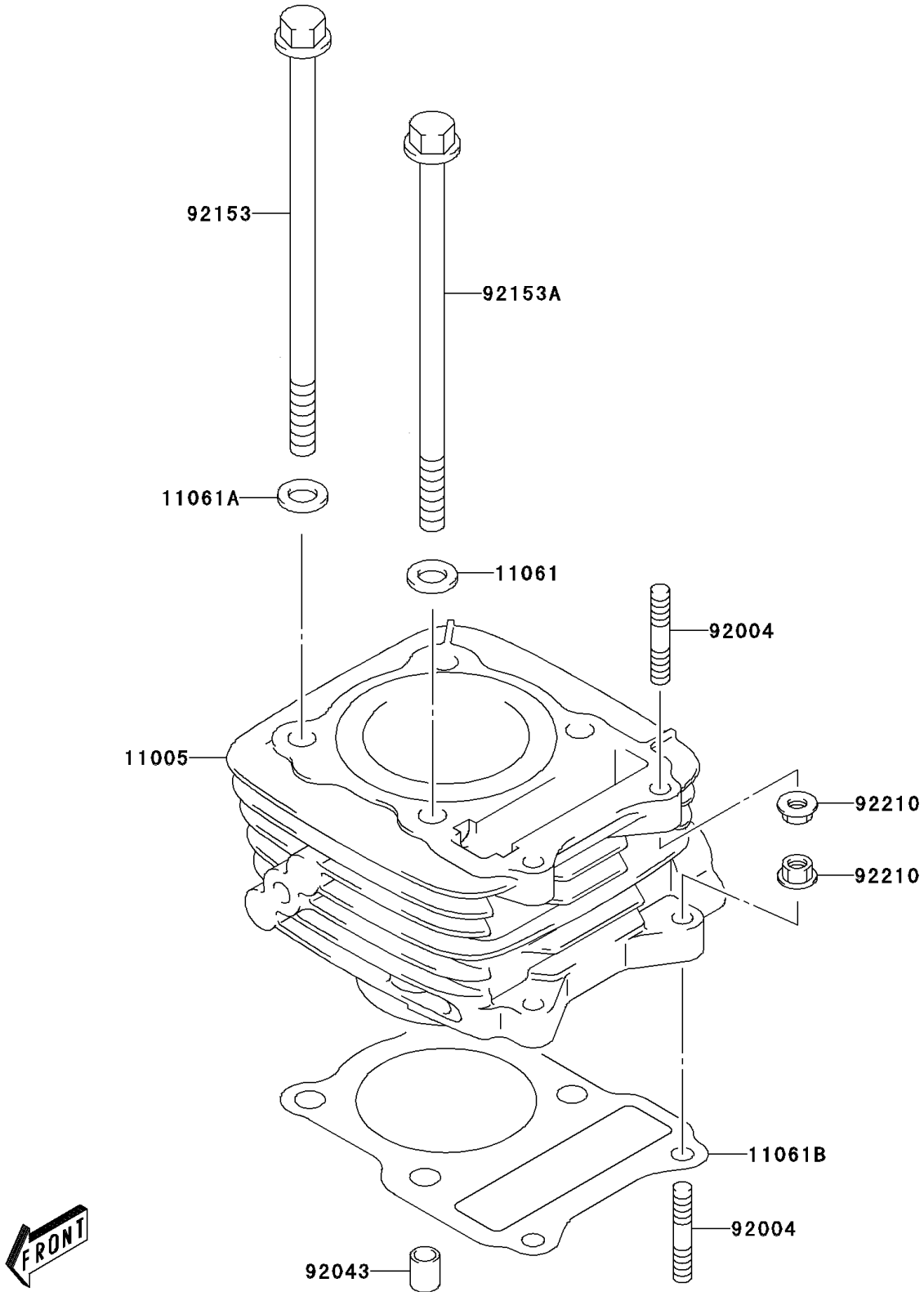

2006 KLX125 PARTS LIST

Cylinder

ITEM NAME	PART NUMBER	QUANTITY
CYLINDER-ENGINE (Ref # 11005)	11005-S004	1
GASKET,8.5X19X2.3 (Ref # 11061)	11061-S032	2
GASKET,8.5X17X2.3 (Ref # 11061A)	11061-S034	2
GASKET,CYLINDER (Ref # 11061B)	11061-S035	1
STUD (Ref # 92004)	92004-S001	4
PIN (Ref # 92043)	92043-S019	2
BOLT,L=165 (Ref # 92153)	92153-S135	2
BOLT,L=155 (Ref # 92153A)	92153-S164	2
NUT (Ref # 92210)	92210-S004	4