

2006 KLX125 PARTS DIAGRAM

Crankshaft/Piston(s)

E1320

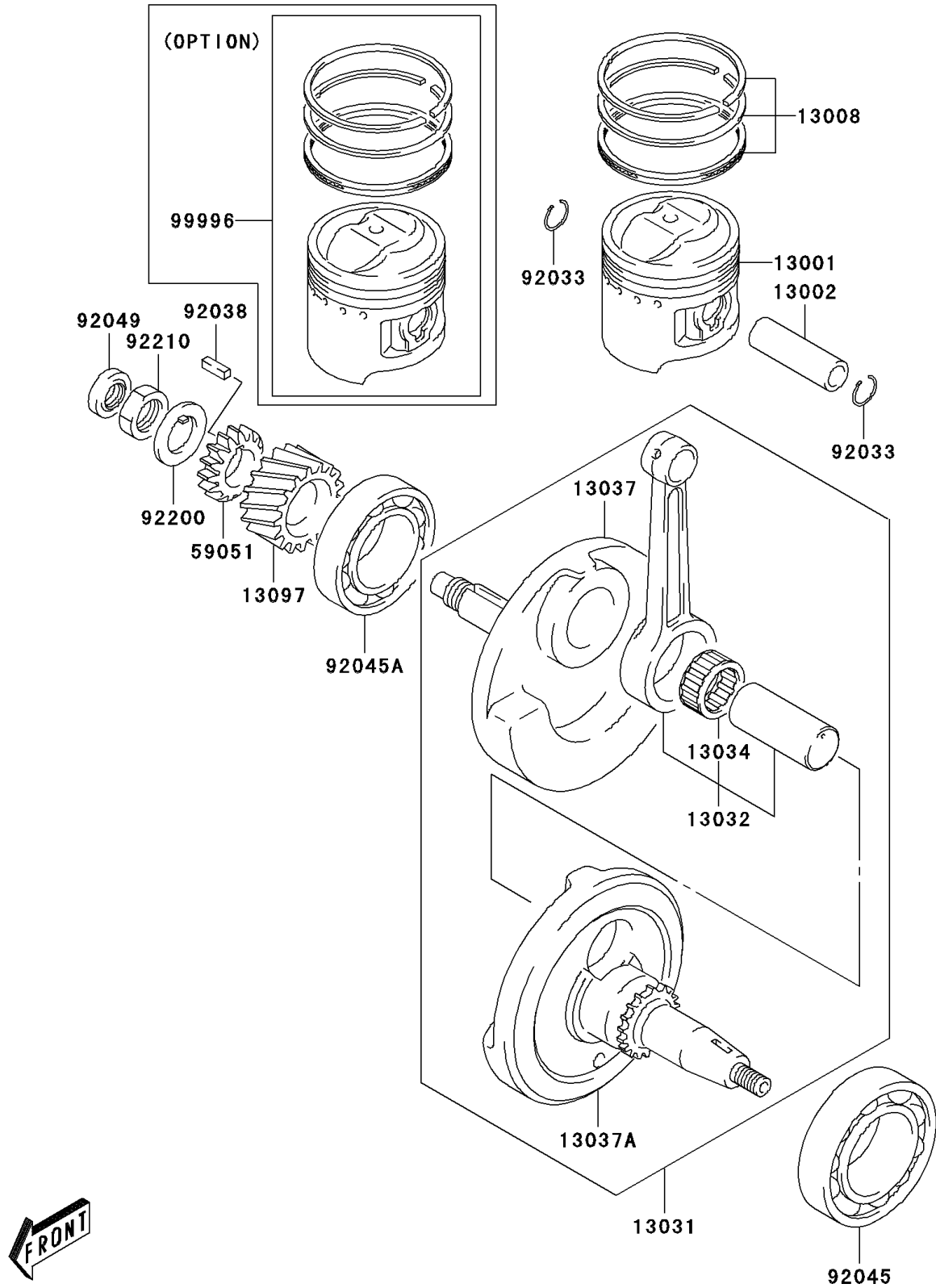

2006 KLX125 PARTS LIST

Crankshaft/Piston(s)

ITEM NAME	PART NUMBER	QUANTITY
PISTON-ENGINE (Ref # 13001)	13001-S003	1
PIN-PISTON (Ref # 13002)	13002-S003	1
RING-SET-PISTON (Ref # 13008)	13008-S003	1
CRANKSHAFT-COMP (Ref # 13031)	13031-S003	1
ROD-CONNECTING (Ref # 13032)	13032-S003	1
BEARING-BIG END,28X36X15.8 (Ref # 13034)	13034-S003	1
CRANKSHAFT,RH (Ref # 13037)	13037-S005	1
CRANKSHAFT,LH (Ref # 13037A)	13037-S006	1
GEAR-PRIMARY SPUR (Ref # 13097)	13097-S003	1
GEAR-SPUR,OIL PUMP DRIVE (Ref # 59051)	59051-S001	1
RING-SNAP (Ref # 92033)	92033-S022	2
KEY,PRIMARY DRIVE (Ref # 92038)	92038-S003	1
BEARING-BALL,35X72X17 (Ref # 92045)	92045-S010	1
BEARING-BALL,28X68X18 (Ref # 92045A)	92045-S026	1
SEAL-OIL,12X21X7 (Ref # 92049)	92049-S001	1
WASHER (Ref # 92200)	92200-S058	1
NUT (Ref # 92210)	92210-S048	1
KIT,PISTON O/S 0.50 (Ref # 99996)	99996-S007	1