

2005 KLX125L PARTS DIAGRAM

Rear Suspension

F2150

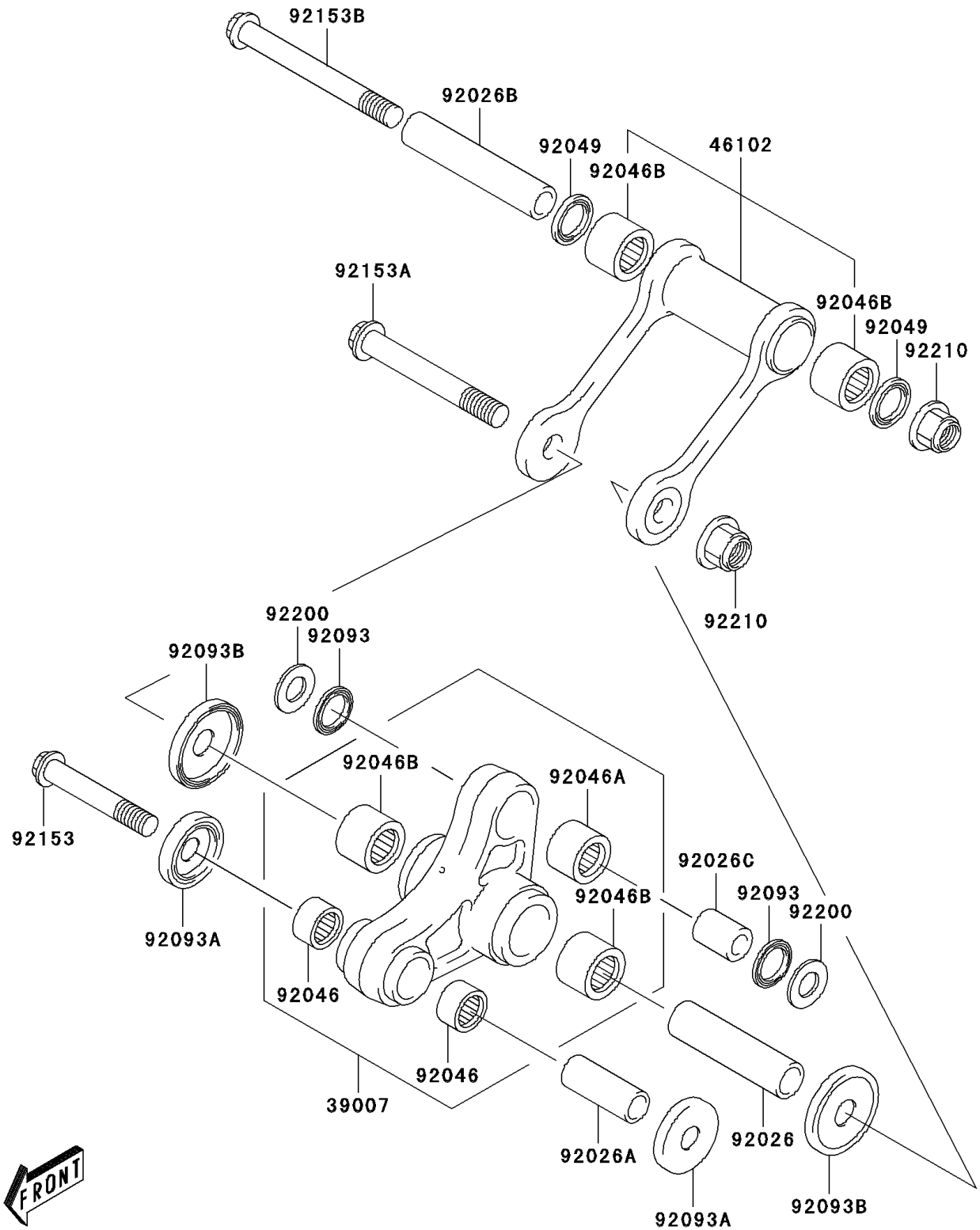

2005 KLX125L PARTS LIST

Rear Suspension

ITEM NAME	PART NUMBER	QUANTITY
ARM-SUSP,REAR CUSHION (Ref # 39007)	39007-S002	1
ROD,REAR CUSHION (Ref # 46102)	46102-S001	1
SPACER,REAR CUSHION (Ref # 92026)	92026-S040	1
SPACER,REAR CUSHION (Ref # 92026A)	92026-S044	1
SPACER,REAR CUSHION ROD (Ref # 92026B)	92026-S045	1
SPACER,REAR CUSHION (Ref # 92026C)	92026-S046	2
BEARING-NEEDLE,14X20X12 (Ref # 92046)	92046-S008	2
BEARING-NEEDLE,16X22X12 (Ref # 92046A)	92046-S009	1
BEARING-NEEDLE,17X24X20 (Ref # 92046B)	92046-S010	4
SEAL-OIL,REAR CUSHION ROD (Ref # 92049)	92049-S024	2
SEAL,REAR CUSHION (Ref # 92093)	92093-S010	2
SEAL,REAR CUSHION (Ref # 92093A)	92093-S013	2
SEAL,REAR CUSHION (Ref # 92093B)	92093-S014	2
BOLT,10X64 (Ref # 92153)	92153-S163	1
BOLT,REAR CUSHION (Ref # 92153A)	92153-S180	1
BOLT,REAR CUSHION (Ref # 92153B)	92153-S181	1
WASHER (Ref # 92200)	92200-S081	2
NUT (Ref # 92210)	92210-S007	2