

2007 KLX250S PARTS DIAGRAM

Front Master Cylinder

F2291

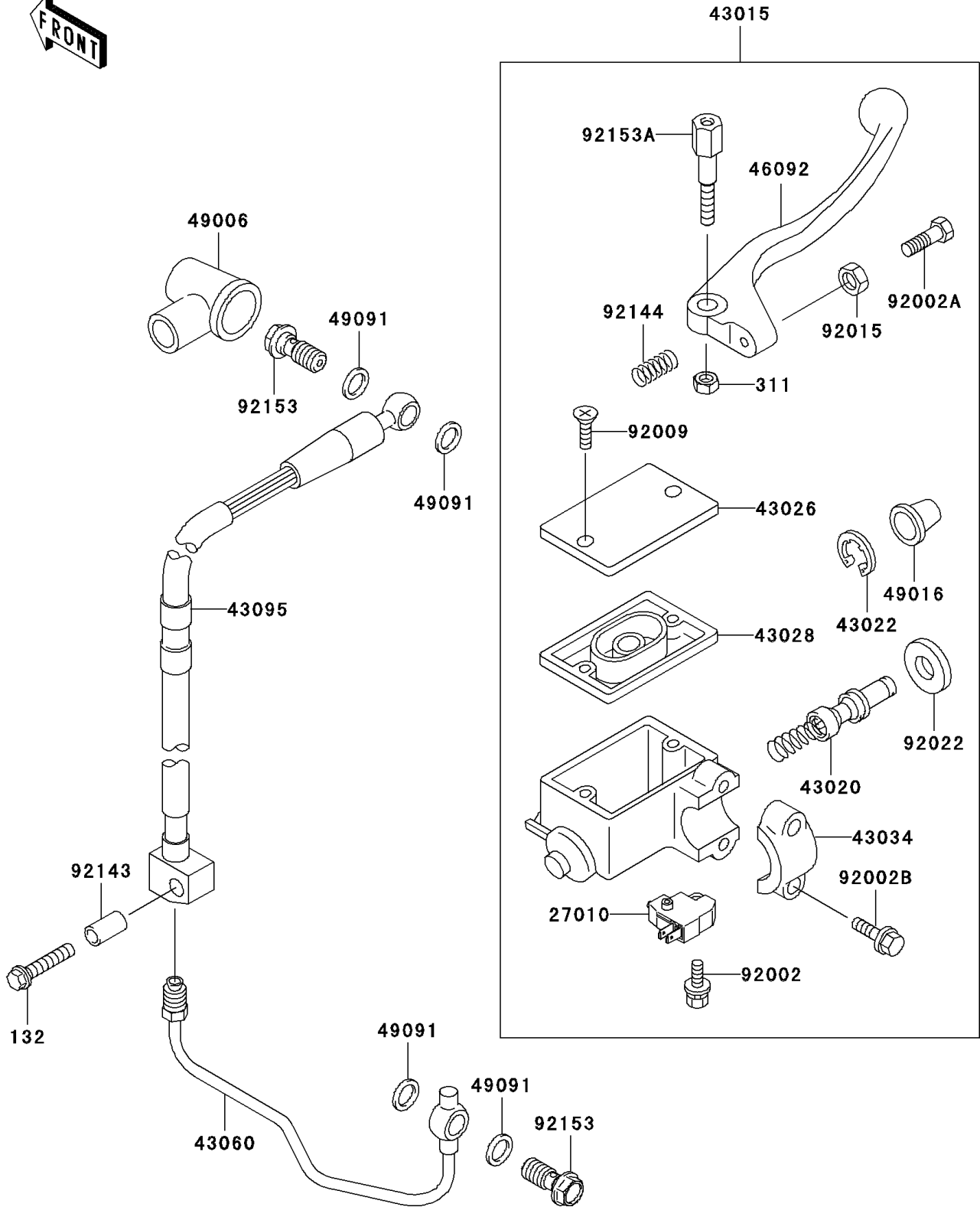

2007 KLX250S PARTS LIST

Front Master Cylinder

ITEM NAME	PART NUMBER	QUANTITY
BOLT-FLANGED-SMALL,6X30 (Ref # 132)	132G0630	1
NUT-HEX (Ref # 311)	311L0600	1
SWITCH,BRAKE (Ref # 27010)	27010-0025	1
CYLINDER-ASSY-MASTER,FR (Ref # 43015)	43015-0040	1
PISTON-COMP-BRAKE (Ref # 43020)	43020-1065	1
STOPPER-BRAKE,PISTON (Ref # 43022)	43022-1010	1
CAP-BRAKE (Ref # 43026)	43026-1074	1
DIAPHRAGM (Ref # 43028)	43028-1061	1
HOLDER-BRAKE,MASTER CYLINDER (Ref # 43034)	43034-1016	1
PIPE-BRAKE,FR (Ref # 43060)	43060-1100	1
HOSE-BRAKE,FR (Ref # 43095)	43095-0163	1
LEVER-GRIP,FRONT BRAKE (Ref # 46092)	46092-1175	1
BOOT,DUST (Ref # 49006)	49006-1040	1
COVER-SEAL,MASTER CYLINDER (Ref # 49016)	49016-1044	1
WASHER-SEAL,10.1X14.5X1.5 (Ref # 49091)	49091-0001	4
BOLT,SCREW,4X12 (Ref # 92002)	92002-1323	1
BOLT,ADJUST (Ref # 92002A)	92002-1893	1
BOLT (Ref # 92002B)	92002-1894	2
SCREW,4MM (Ref # 92009)	92009-1458	2
NUT,ADJUST (Ref # 92015)	92015-1642	1
WASHER (Ref # 92022)	92022-1814	1
COLLAR,6.5X9.5X17 (Ref # 92143)	92143-1408	1
SPRING,RETURN (Ref # 92144)	92144-1103	1
BOLT,OIL,L=23 (Ref # 92153)	92153-0627	2
BOLT,LEVER SET (Ref # 92153A)	92153-0790	1