

2009 Concours™ 14 PARTS DIAGRAM

Cables

F2540

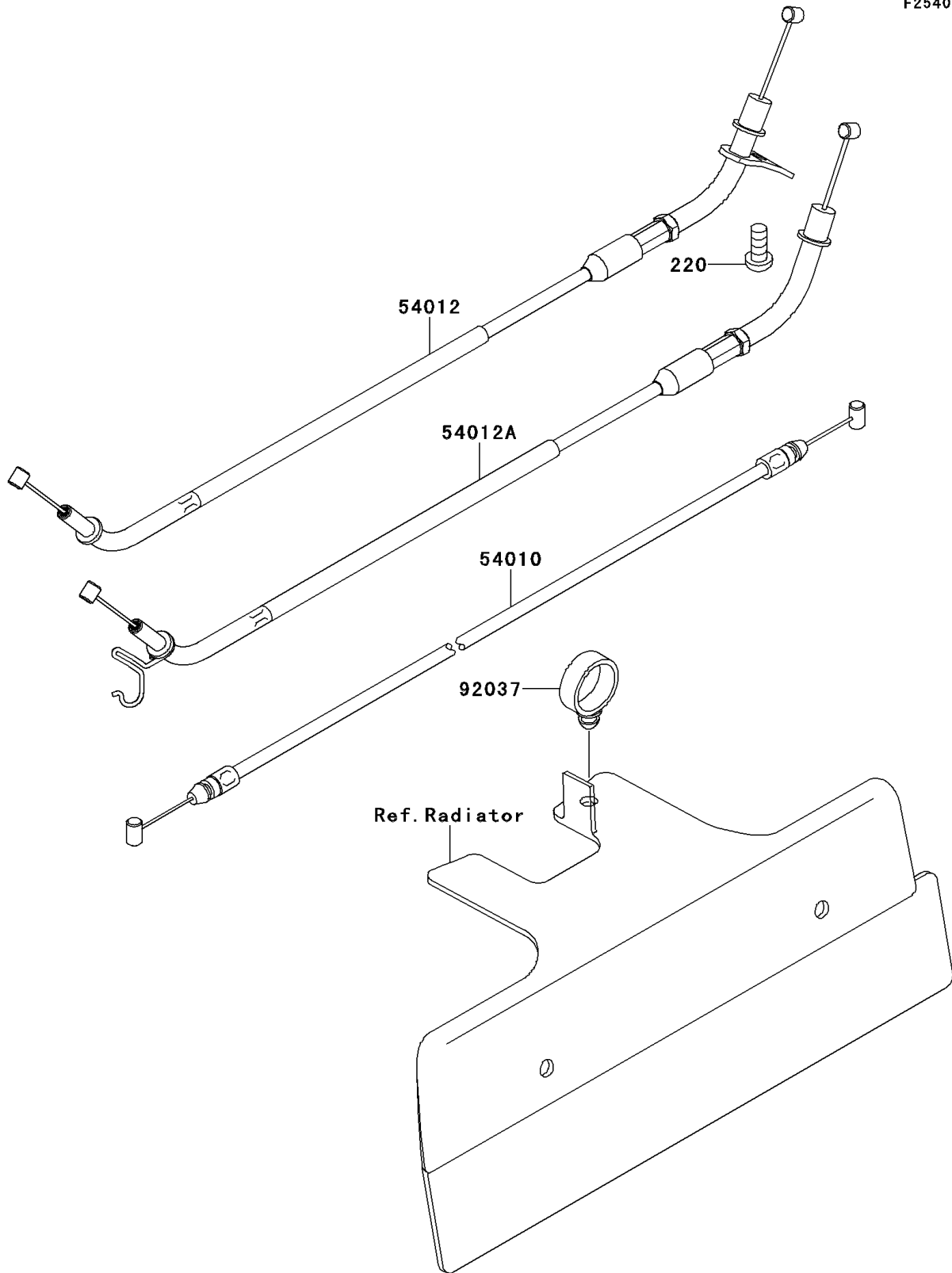

2009 Concours™ 14 PARTS LIST

Cables

ITEM NAME	PART NUMBER	QUANTITY
SCREW-PAN-CROS,6X14 (Ref # 220)	220AB0614	1
CABLE,SEAT LOCK (Ref # 54010)	54010-0066	1
CABLE-THROTTLE,CLOSING (Ref # 54012)	54012-0199	1
CABLE-THROTTLE,OPENING (Ref # 54012A)	54012-0223	1
CLAMP,HOSE (Ref # 92037)	92037-1827	1