

1999 KLX300R PARTS DIAGRAM

Cylinder/Piston(s)

E1120

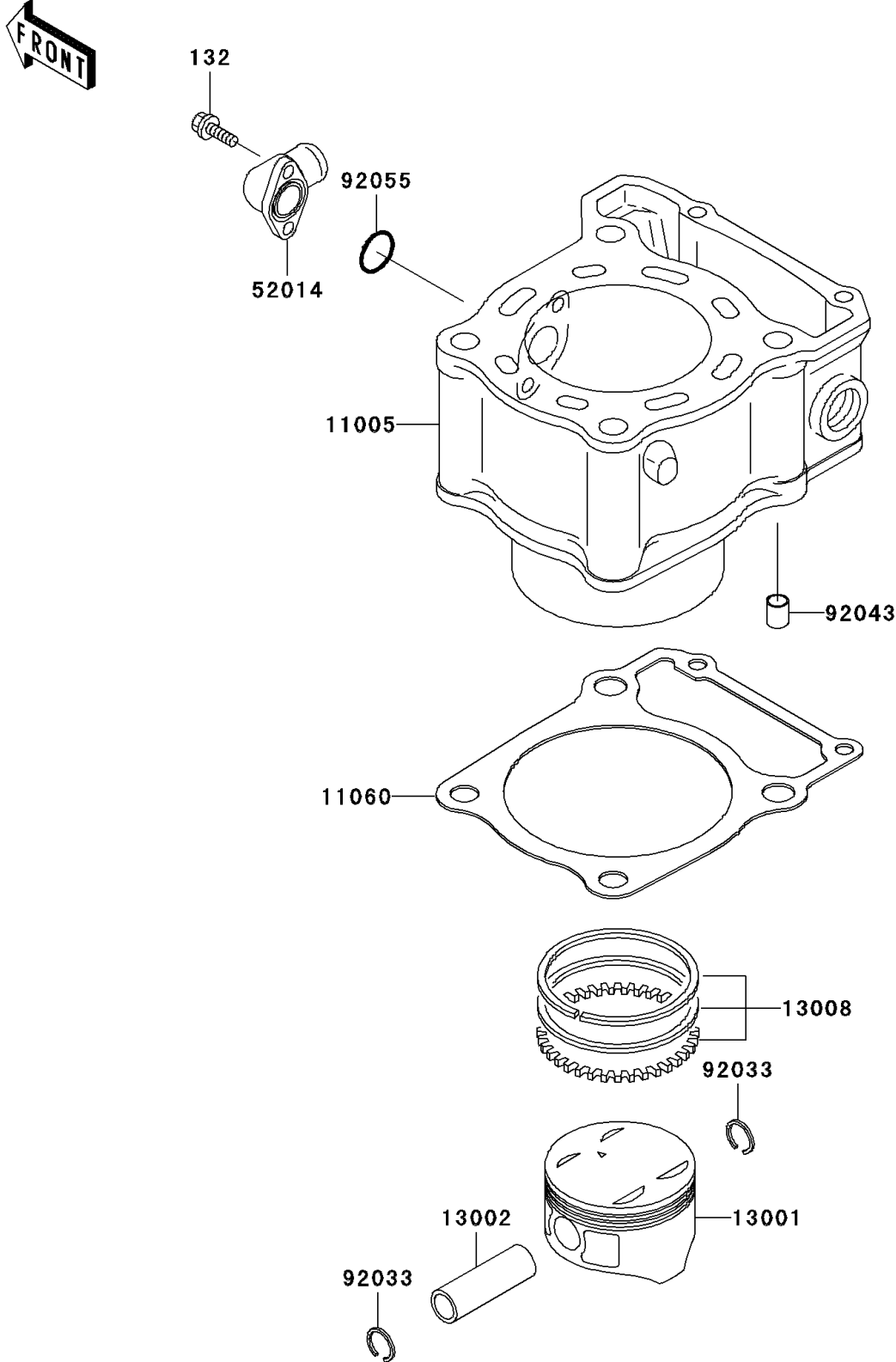

1999 KLX300R PARTS LIST

Cylinder/Piston(s)

ITEM NAME	PART NUMBER	QUANTITY
BOLT-FLANGED-SMALL (Ref # 132)	132Y0614	2
CYLINDER-ENGINE (Ref # 11005)	11005-1816	1
GASKET,CYLINDER BASE (Ref # 11060)	11060-1740	1
PISTON-ENGINE (Ref # 13001)	13001-1463	1
PIN-PISTON (Ref # 13002)	13002-1109	1
RING-SET-PISTON,STD (Ref # 13008)	13008-1071	1
ELBOW (Ref # 52014)	52014-1084	1
RING-SNAP (Ref # 92033)	92033-1054	2
PIN,10.1X12X14 (Ref # 92043)	92043-4009	2
RING-O,19.5X1.5 (Ref # 92055)	92055-055	1