

1998 KLX300R PARTS DIAGRAM

Air Cleaner

E1130

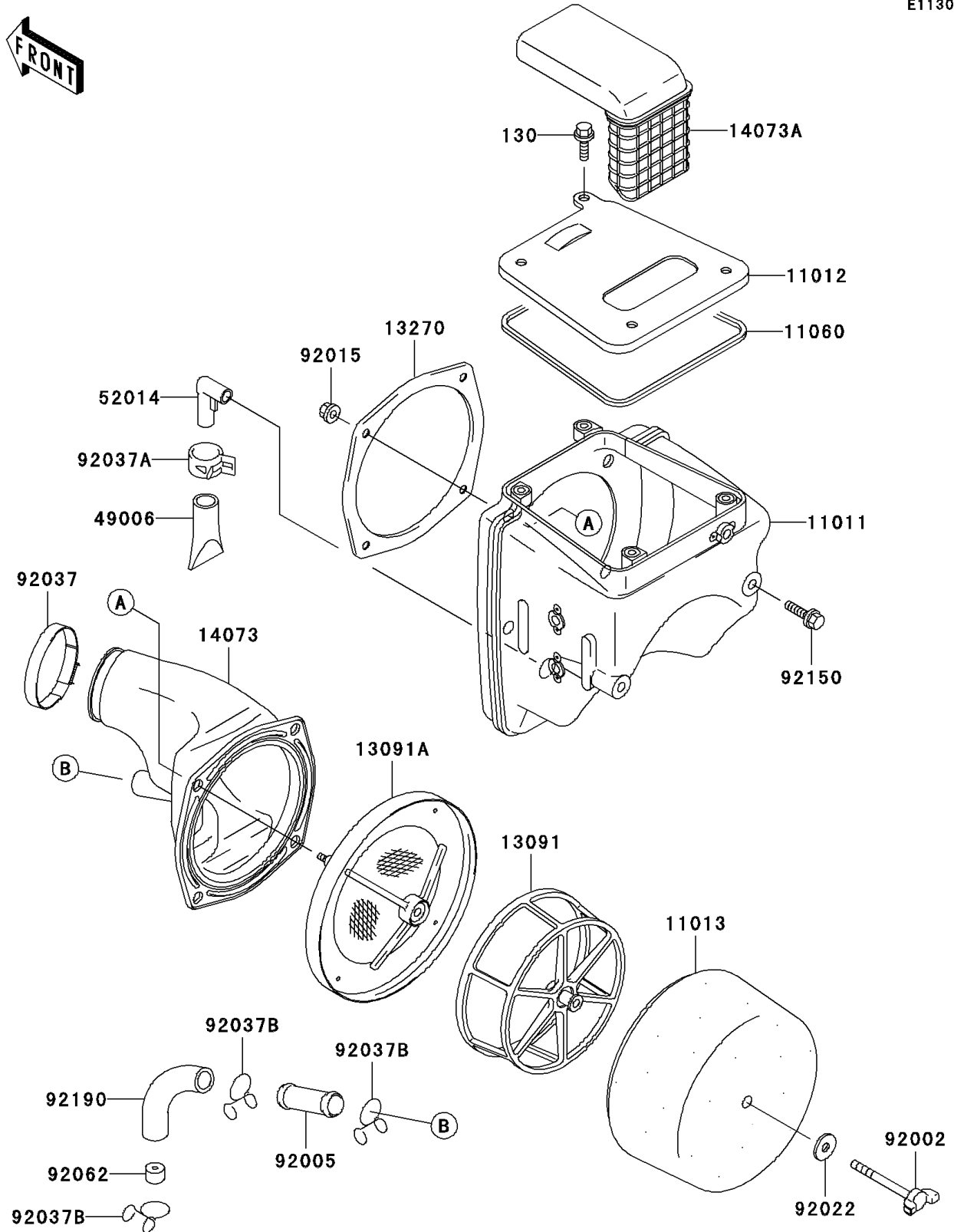

1998 KLX300R PARTS LIST

Air Cleaner

ITEM NAME	PART NUMBER	QUANTITY
BOLT-FLANGED,6X12 (Ref # 130)	130G0612	4
CASE-AIR FILTER (Ref # 11011)	11011-1399	1
CAP,AIR FILTER (Ref # 11012)	11012-1834	1
ELEMENT-AIR FILTER (Ref # 11013)	11013-1260	1
GASKET,AIR FILTER CASE (Ref # 11060)	11060-1323	1
HOLDER,ELEMENT (Ref # 13091)	13091-1454	1
HOLDER,ELEMENT (Ref # 13091A)	13091-1835	1
PLATE,DUCT FITTING (Ref # 13270)	13270-1284	1
DUCT,AIR FILTER (Ref # 14073)	14073-1566	1
BOOT (Ref # 49006)	49006-1211	1
ELBOW (Ref # 52014)	52014-1083	1
BOLT,WING (Ref # 92002)	92002-1719	1
FITTING (Ref # 92005)	92005-1236	1
NUT,FLANGED,5MM (Ref # 92015)	92015-1656	4
WASHER,6.5X20X1.6 (Ref # 92022)	92022-125	1
CLAMP (Ref # 92037)	92037-1554	1
CLAMP (Ref # 92037A)	92037-2082	1
CLAMP,TUBE (Ref # 92037B)	92037-213	3
NOZZLE (Ref # 92062)	92062-1076	1
BOLT,6X20 (Ref # 92150)	92150-1339	3
TUBE,BREATHER (Ref # 92190)	92190-1397	1
DUCT,AIR INTAKE (Ref # 14073A)	14073-1588	1