

1999 KLX300R PARTS DIAGRAM

Gear Change Mechanism

E1370

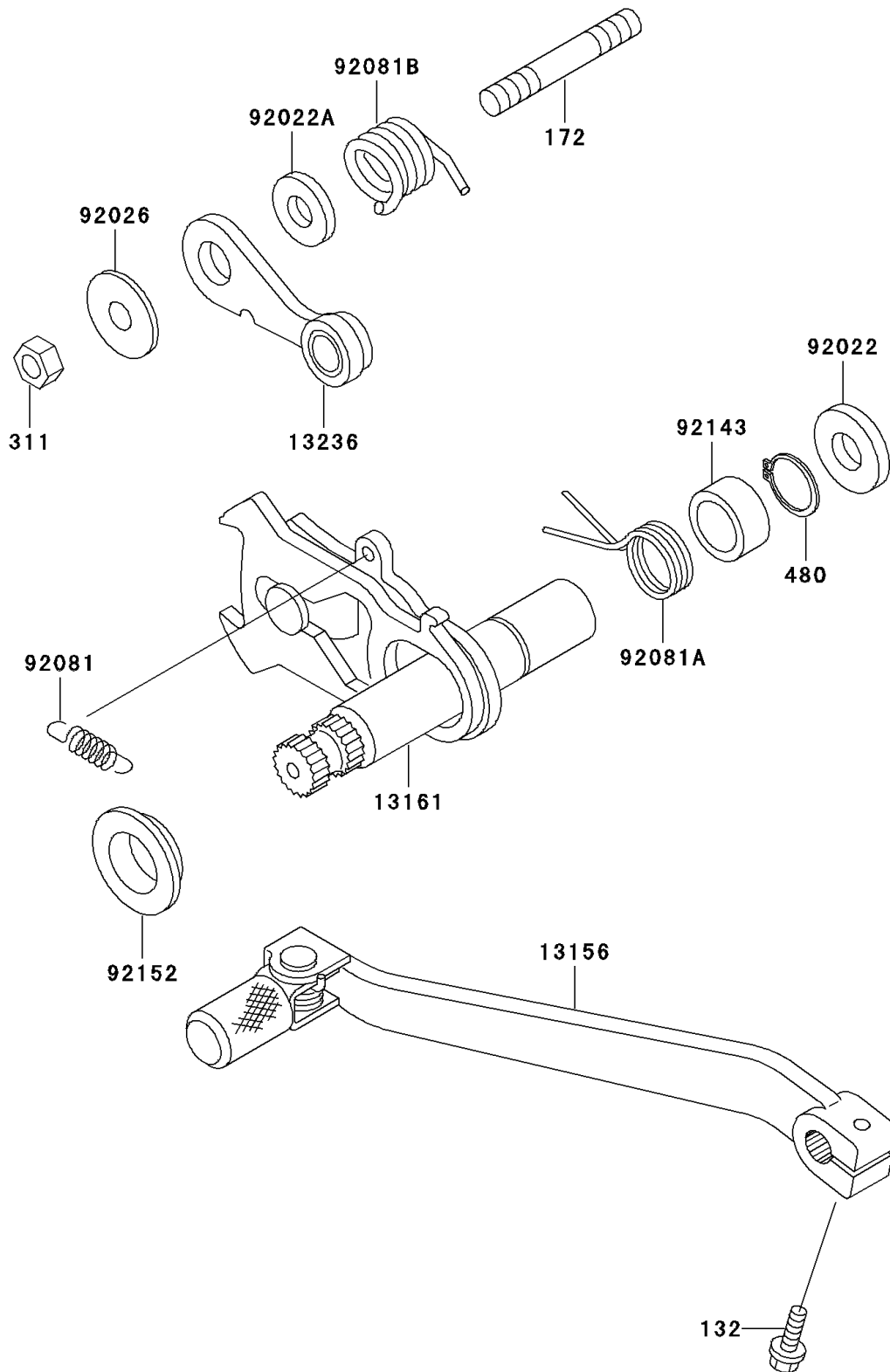

1999 KLX300R PARTS LIST

Gear Change Mechanism

ITEM NAME	PART NUMBER	QUANTITY
BOLT-FLANGED-SMALL (Ref # 132)	132Y0620	1
BOLT-STUD,6X12 (Ref # 172)	172G0612	1
NUT-HEX,6MM (Ref # 311)	311G0600	1
CIRCLIP-TYPE-C,13MM (Ref # 480)	480J1300	1
LEVER-CHANGE,PEDAL (Ref # 13156)	13156-1340	1
LEVER-COMP-CHANGE SHAFT (Ref # 13161)	13161-1213	1
LEVER-COMP,NEUTRAL POSITION (Ref # 13236)	13236-1209	1
WASHER,13.3X20X1 (Ref # 92022)	92022-1496	1
WASHER,6X12.8X1.2 (Ref # 92022A)	92022-1827	1
SPACER (Ref # 92026)	92026-1217	1
SPRING,CHANGE LEVER (Ref # 92081)	92081-076	1
SPRING,TENSION (Ref # 92081A)	92081-1129	1
SPRING,POSITION LEVER (Ref # 92081B)	92081-1993	1
COLLAR (Ref # 92143)	92143-1148	1
COLLAR (Ref # 92152)	92152-1075	1