

# 2001 KLX300R PARTS DIAGRAM

Crankcase

E1411

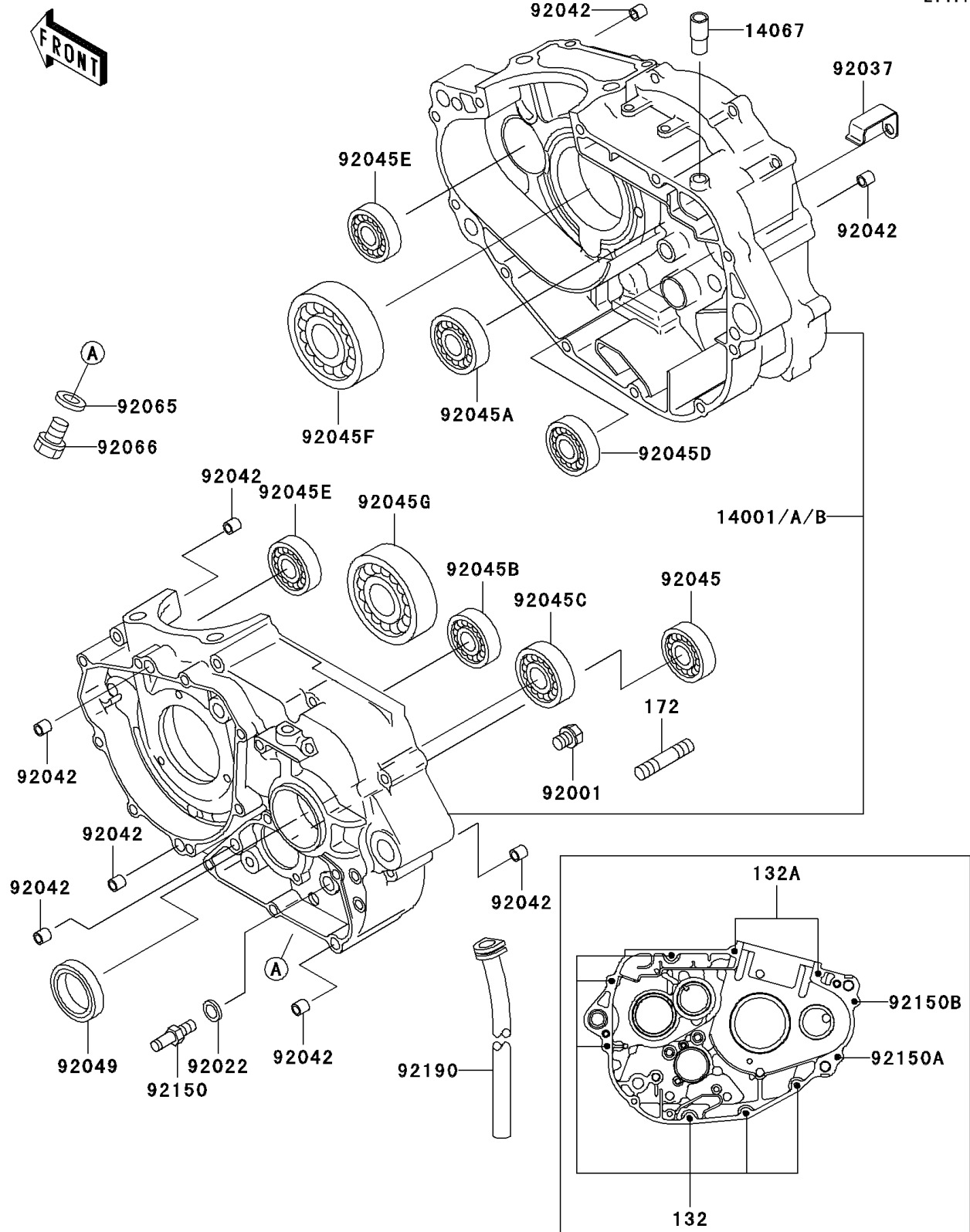

## 2001 KLX300R PARTS LIST

### Crankcase

ITEM NAME	PART NUMBER	QUANTITY
BOLT-FLANGED-SMALL (Ref # 132)	132Y0650	6
BOLT-FLANGED-SMALL (Ref # 132A)	132Y0670	2
BOLT-STUD,6X80 (Ref # 172)	172G0680	1
SET-CRANKCASE (Ref # 14001A)	14001-5355	1
FITTING,BREATHER (Ref # 14067)	14067-006	1
BOLT,W/WASHER,6X14 (Ref # 92001)	92001-1829	2
WASHER,10.2X18X1.0,SK5 (Ref # 92022)	92022-1415	1
CLAMP,HARNESS (Ref # 92037)	92037-1318	1
PIN,DOWEL,6.3X8X14 (Ref # 92042)	92042-007	8
BEARING-BALL,#6905 (Ref # 92045)	92045-036	1
BEARING-BALL,TMB204 JR (Ref # 92045A)	92045-1041	1
BEARING-BALL,TMB203LU (Ref # 92045B)	92045-1287	1
BEARING-BALL,TMB205LU (Ref # 92045C)	92045-1288	1
BEARING-BALL,TMB203 (Ref # 92045D)	92045-1291	1
BEARING-BALL,TMB302JR2 (Ref # 92045E)	92045-1346	2
BEARING-BALL,TMB306JR2 (Ref # 92045F)	92045-1347	1
BEARING-BALL,3TM-6207CJR2 (Ref # 92045G)	92045-1348	1
SEAL-OIL,TC32457 (Ref # 92049)	92049-1159	1
GASKET,10.5X16X1 (Ref # 92065)	92065-058	1
PLUG,DRAIN (Ref # 92066)	92066-1241	1
BOLT,RETURN SPRING (Ref # 92150)	92150-1803	1
BOLT,SOCKET,6X50 (Ref # 92150A)	92150-1874	1
BOLT,SOCKET,6X35 (Ref # 92150B)	92150-1875	1
TUBE (Ref # 92190)	92190-1493	1