

1999 KLX300R PARTS DIAGRAM

Ignition System

E1830

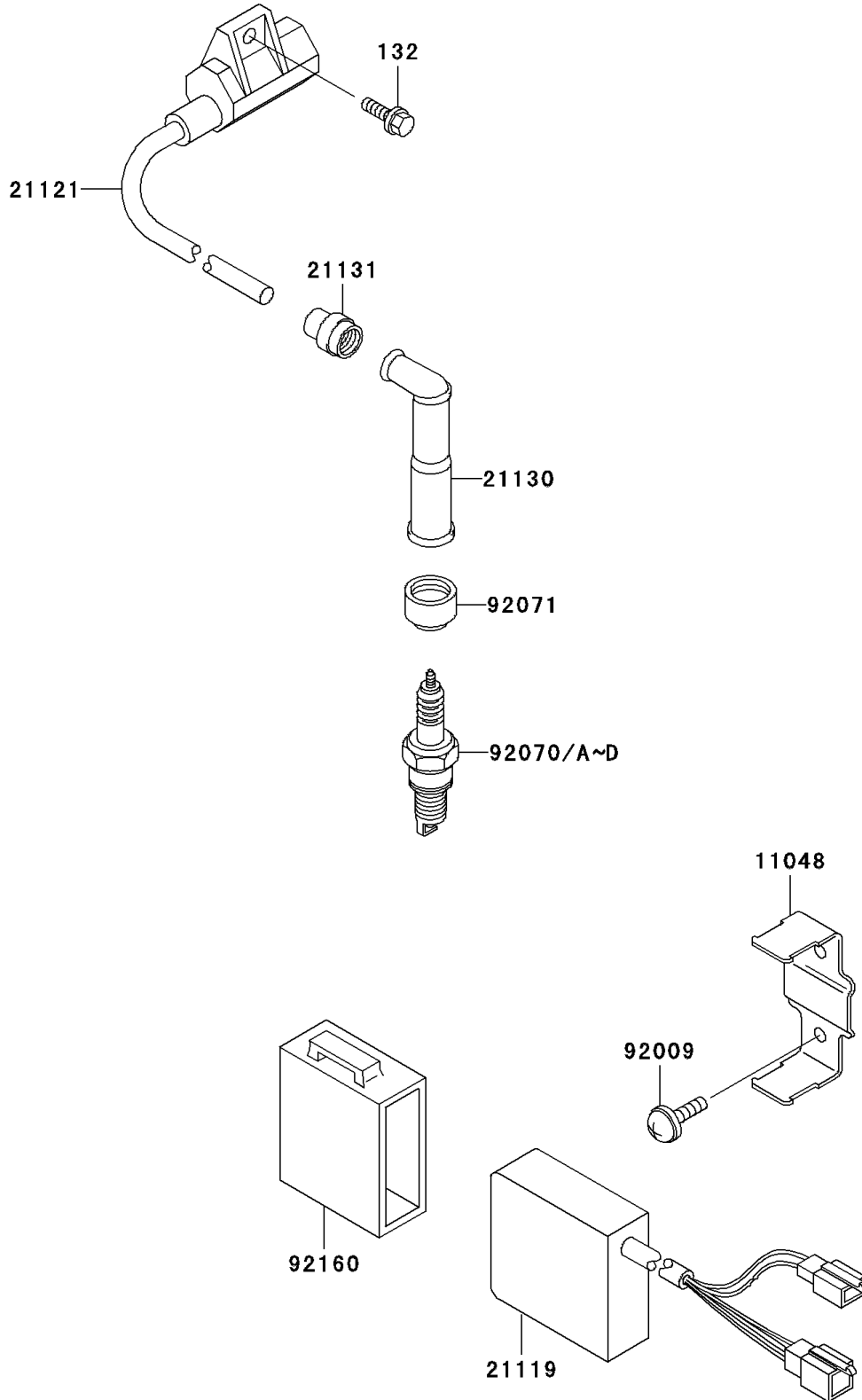

1999 KLX300R PARTS LIST

Ignition System

ITEM NAME	PART NUMBER	QUANTITY
BOLT-FLANGED-SMALL (Ref # 132)	132J0616	1
BRACKET (Ref # 11048)	11048-1291	1
IGNITER (Ref # 21119)	21119-1479	1
COIL-IGNITION (Ref # 21121)	21121-1152	1
CAP-SPARK PLUG (Ref # 21130)	21130-1002	1
GROMMET,HIGH TENSION (Ref # 21131)	21131-005	1
SCREW,6X18,BLACK (Ref # 92009)	92009-1181	2
PLUG-SPARK,U27ESR-N(ND) (Ref # 92070)		1
PLUG-SPARK,CR8E(NGK) (Ref # 92070A)	92070-1169	1
PLUG-SPARK,U24ESR-N(ND) (Ref # 92070B)		1
PLUG-SPARK,CR7E(NGK) (Ref # 92070C)	92070-1209	1
PLUG-SPARK,CR9E(NGK) (Ref # 92070D)	92070-1266	1
GROMMET,PLUG CAP (Ref # 92071)	92071-1124	1
DAMPER,IGNITER (Ref # 92160)	92160-1259	1