

2000 KLX300R PARTS DIAGRAM

Water Pump

E3031

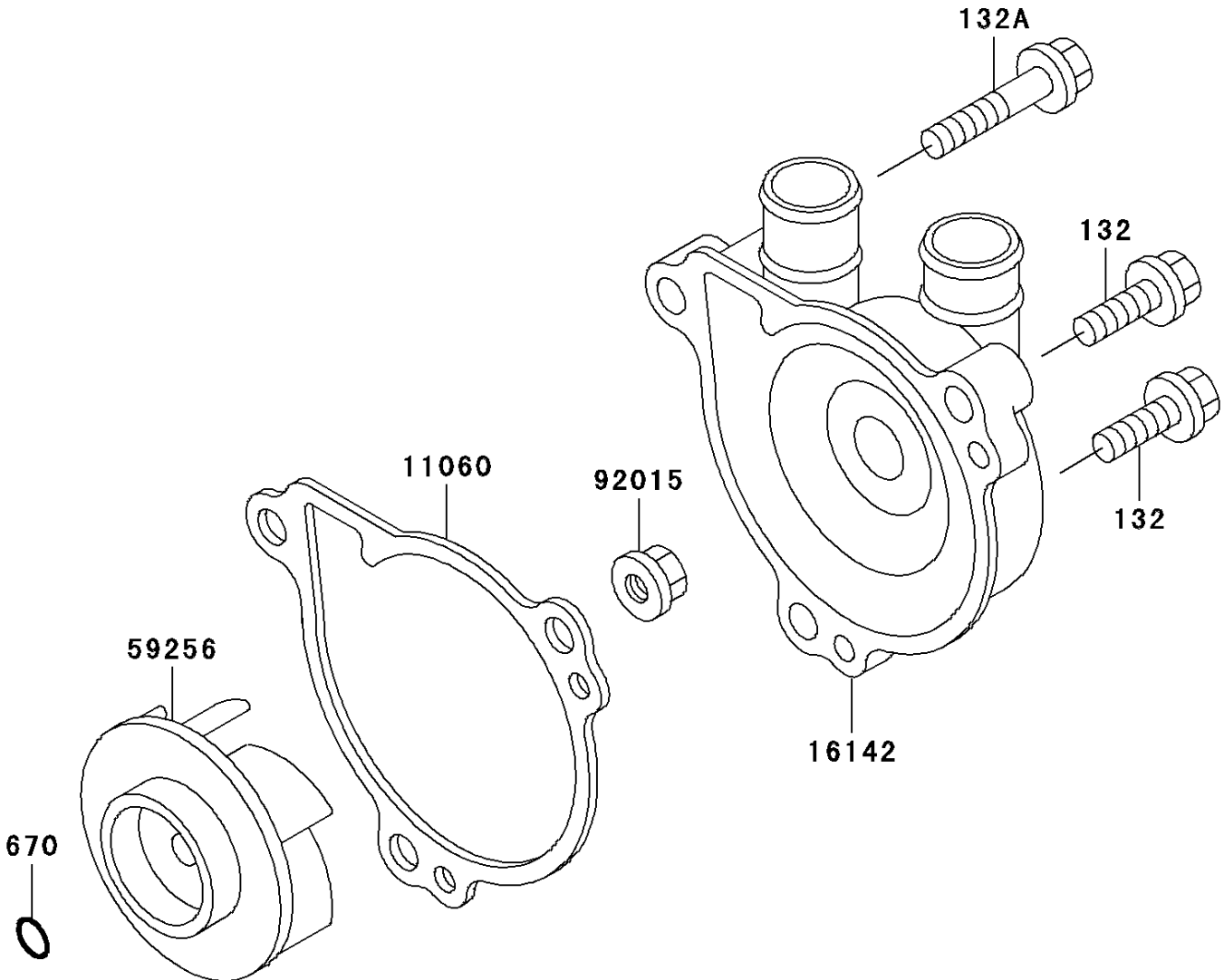

2000 KLX300R PARTS LIST

Water Pump

ITEM NAME	PART NUMBER	QUANTITY
BOLT-FLANGED-SMALL (Ref # 132)	132Y0625	2
BOLT-FLANGED-SMALL (Ref # 132A)	132Y0665	1
O RING,6MM (Ref # 670)	670B1506	1
GASKET,PUMP COVER (Ref # 11060)	11060-1328	1
COVER-PUMP (Ref # 16142)	16142-1125	1
IMPELLER (Ref # 59256)	59256-1063	1
NUT,FLANGED,6MM (Ref # 92015)	92015-1078	1