

1999 KLX300R PARTS DIAGRAM

Frame Fittings

F2131

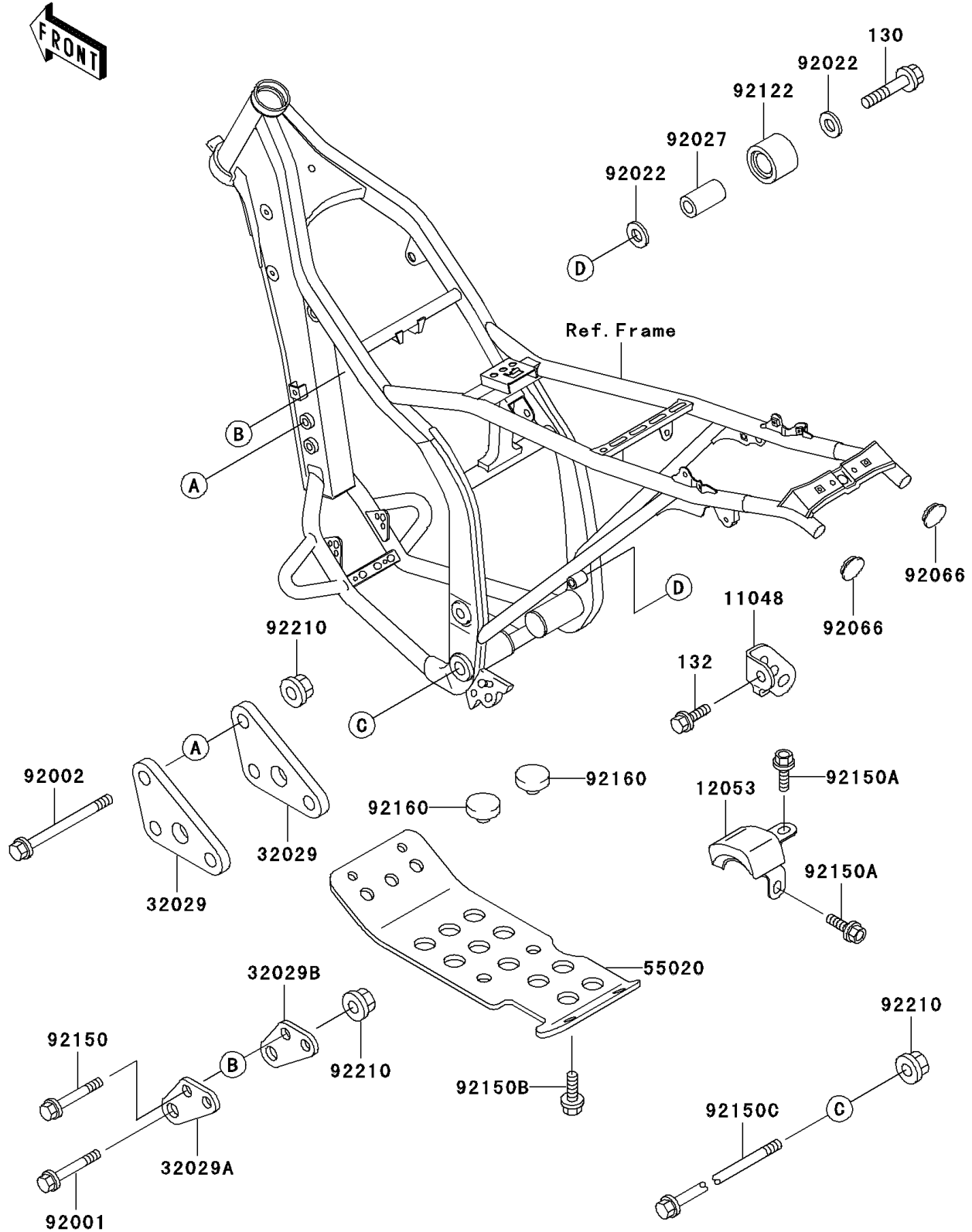

1999 KLX300R PARTS LIST

Frame Fittings

ITEM NAME	PART NUMBER	QUANTITY
BOLT-FLANGED,8X40 (Ref # 130)	130G0840	1
BOLT-FLANGED-SMALL (Ref # 132)	132G0612	1
BRACKET,AIR FILTER,LWR,LH (Ref # 11048)	11048-1223	1
GUIDE-CHAIN (Ref # 12053)	12053-1314	1
BRACKET-ENGINE,FR (Ref # 32029)	32029-1855	2
BRACKET-ENGINE,HEAD,LH (Ref # 32029A)	32029-1886	1
BRACKET-ENGINE,HEAD,RH (Ref # 32029B)	32029-1887	1
GUARD,ENGINE (Ref # 55020)	55020-1456	1
BOLT,10X44 (Ref # 92001)	92001-1499	1
BOLT,10X90 (Ref # 92002)	92002-1674	3
WASHER,8.5X20X1.6 (Ref # 92022)	92022-1561	2
COLLAR,CHAIN ROLLER (Ref # 92027)	92027-1670	1
PLUG,FRAME END,12X13 (Ref # 92066)	92066-1034	2
ROLLER,CHAIN GUIDE (Ref # 92122)	92122-1153	1
BOLT,FLANGED,8X40 (Ref # 92150)	92150-1168	2
BOLT,6X14 (Ref # 92150A)	92150-1340	2
BOLT,6X12 (Ref # 92150B)	92150-1435	4
BOLT,FLANGED,10X120 (Ref # 92150C)	92150-1642	1
DAMPER,ENGINE GUARD (Ref # 92160)	92160-1396	2
NUT,LOCK,FLANGED,10MM (Ref # 92210)	92210-1080	5