

2018 KX™ 450F PARTS DIAGRAM

Gear Change Drum/Shift Fork(s)

E1362

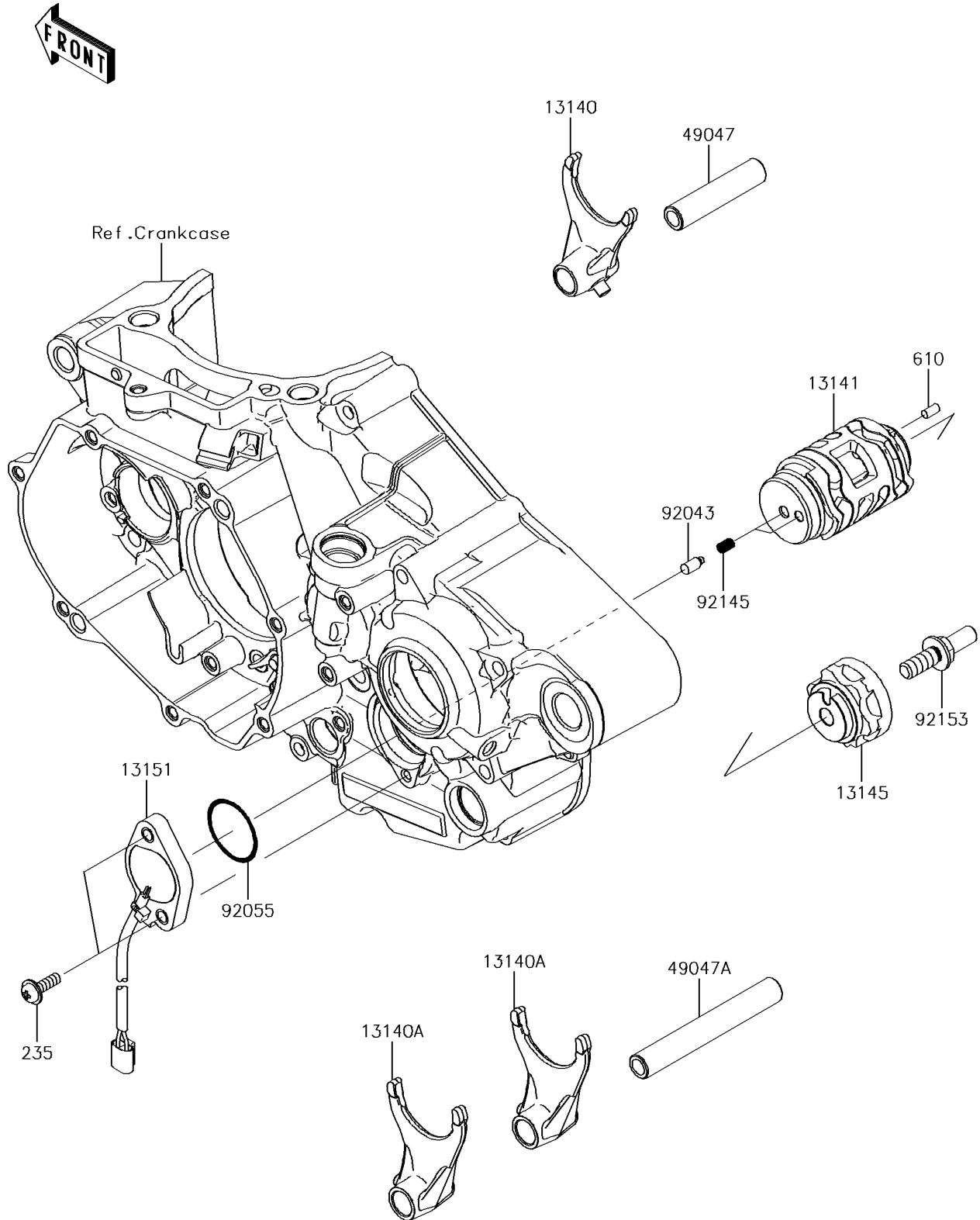

2018 KX™ 450F PARTS LIST

Gear Change Drum/Shift Fork(s)

ITEM NAME	PART NUMBER	QUANTITY
FORK-SHIFT,INPUT (Ref # 13140)	13140-0647	1
FORK-SHIFT,OUTPUT (Ref # 13140A)	13140-0648	2
DRUM-CHANGE (Ref # 13141)	13141-0588	1
CAM-CHANGE DRUM (Ref # 13145)	13145-0563	1
SWITCH-COMP,GEAR POSITION (Ref # 13151)	13151-0568	1
SCREW-PAN-WP-CROS,5X16 (Ref # 235)	235AB0516	2
ROD-SHIFT,INPUT (Ref # 49047)	49047-0628	1
ROD-SHIFT,OUTPUT (Ref # 49047A)	49047-0629	1
ROLLER,4X8 (Ref # 610)	610A0408	1
PIN (Ref # 92043)	92043-1654	2
RING-O,27.7X2.4 (Ref # 92055)	92055-091	1
SPRING (Ref # 92145)	92145-1414	2
BOLT,8X20 (Ref # 92153)	92153-0530	1