

1999 KLX300R PARTS DIAGRAM

Front Hub

F2230

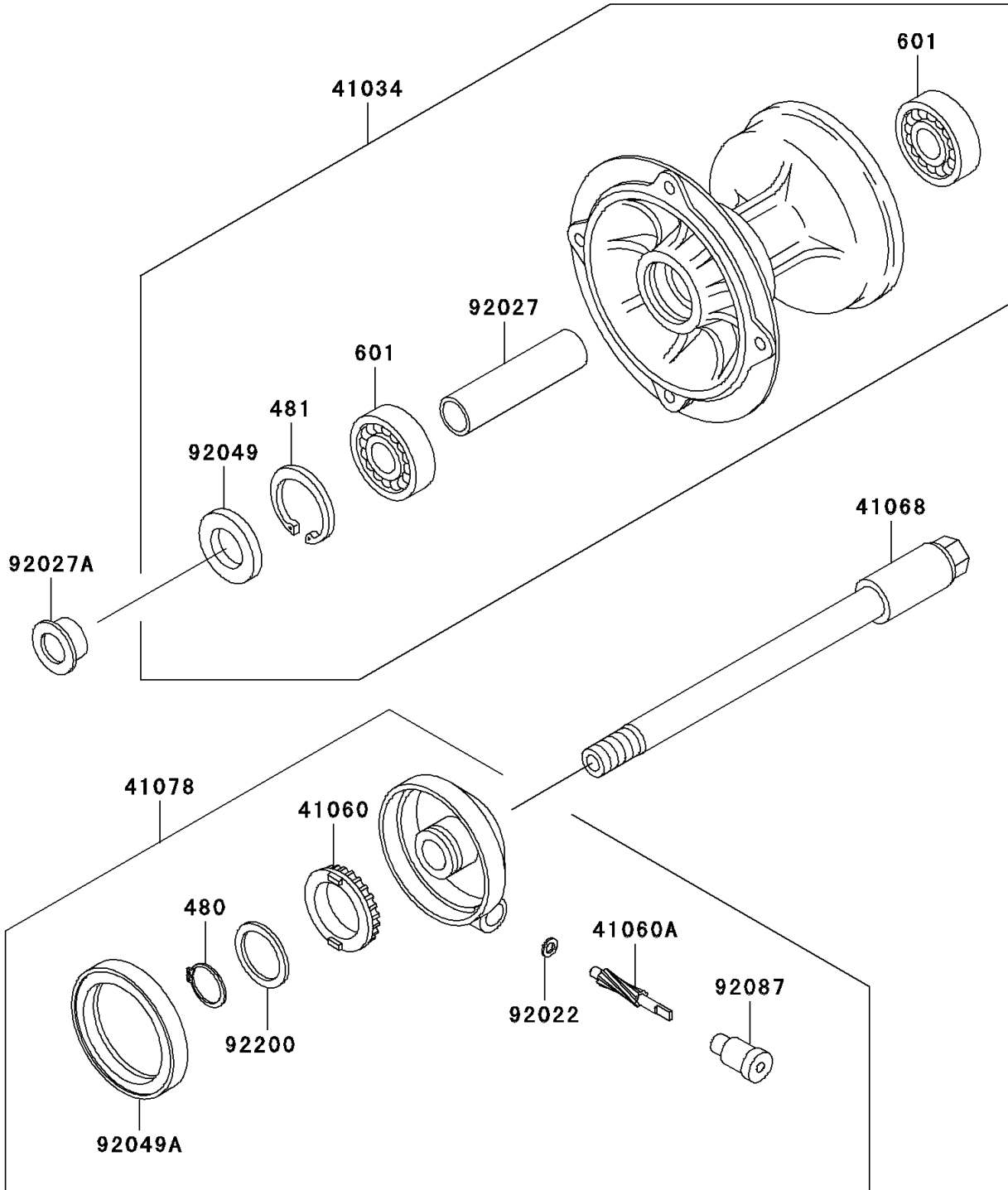

1999 KLX300R PARTS LIST

Front Hub

ITEM NAME	PART NUMBER	QUANTITY
CIRCLIP-TYPE-C,24MM (Ref # 480)	480J2400	1
CIRCLIP-TYPE-C,35MM (Ref # 481)	481J3500	1
BEARING-BALL,#6202UG (Ref # 601)	601B6202UG	2
DRUM-ASSY,FRONT BRAKE (Ref # 41034)	41034-1219	1
GEAR-METER SCREW,25T (Ref # 41060)	41060-1143	1
GEAR-METER SCREW,8T (Ref # 41060A)	41060-1144	1
AXLE,FR (Ref # 41068)	41068-1352	1
CASE-ASSY-METER GEAR (Ref # 41078)	41078-1095	1
WASHER,5X9.5X0.8 (Ref # 92022)	92022-1511	1
COLLAR,15.2X22.2X75 (Ref # 92027)	92027-1958	1
COLLAR,L=12 (Ref # 92027A)	92027-1959	1
SEAL-OIL,MH20354.5 (Ref # 92049)	92049-1176	1
SEAL-OIL,SDD 50 62 7 (Ref # 92049A)	92049-1399	1
BUSHING-METER GEAR (Ref # 92087)	92087-1060	1
WASHER,24X31X0.8 (Ref # 92200)	92200-1137	1