

2001 KLX300R PARTS DIAGRAM

Taillight(s)

F2720

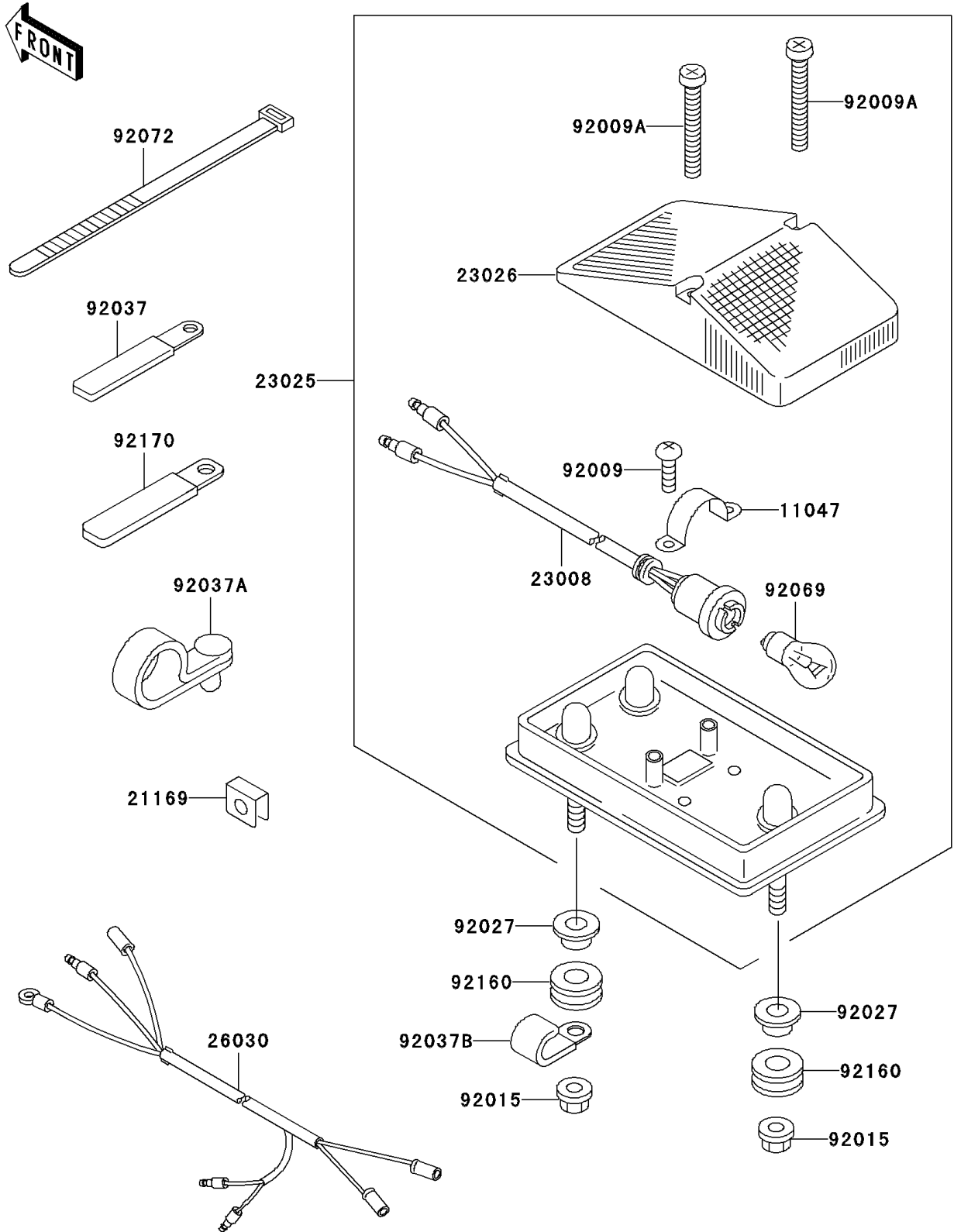

2001 KLX300R PARTS LIST

Taillight(s)

ITEM NAME	PART NUMBER	QUANTITY
BRACKET,TAIL LAMP (Ref # 11047)	11047-1238	1
TERMINAL (Ref # 21169)	21169-1066	1
SOCKET-ASSY,TAIL LAMP (Ref # 23008)	23008-1462	1
LAMP-TAIL (Ref # 23025)	23025-1215	1
LENS,TAIL LAMP (Ref # 23026)	23026-1131	1
HARNESS,MAIN (Ref # 26030)	26030-1165	1
SCREW,TAPPING,4X10 (Ref # 92009)	92009-1021	2
SCREW,TAPPING,4X30 (Ref # 92009A)	92009-1647	2
NUT,FLANGED,6MM (Ref # 92015)	92015-1367	3
COLLAR,L=14.1 (Ref # 92027)	92027-1920	3
CLAMP,WIRING HARNESS,L=60 (Ref # 92037)	92037-1069	1
CLAMP,SPEED,L=58 (Ref # 92037A)	92037-1163	1
CLAMP,WIRING HARNESS (Ref # 92037B)	92037-1877	1
BULB,12V 10W (Ref # 92069)	92069-1072	1
BAND,L=202 (Ref # 92072)	92072-1195	6
DAMPER (Ref # 92160)	92160-1167	3
CLAMP,L=150 (Ref # 92170)	92170-1114	1