

1999 KLX300R PARTS DIAGRAM

Owner's Tools

F2810

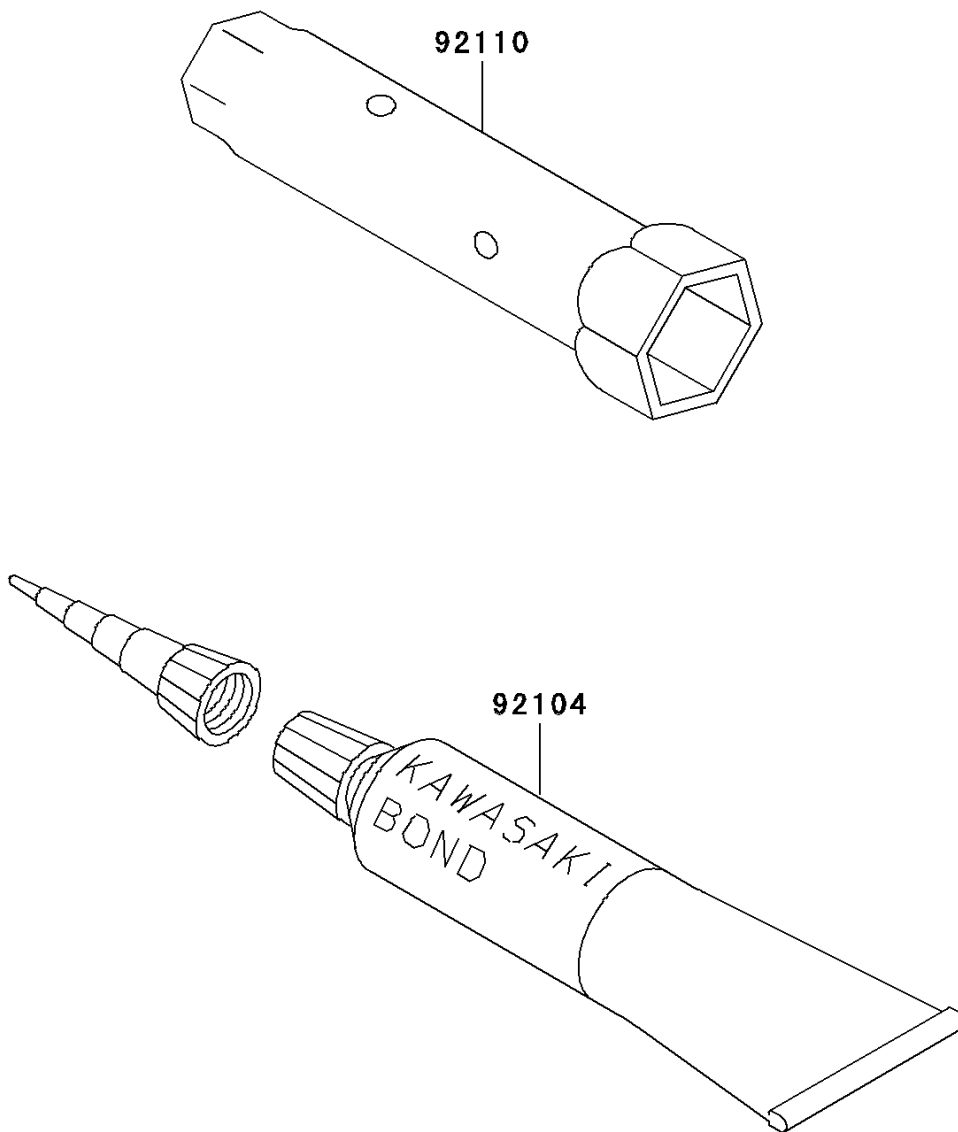

1999 KLX300R PARTS LIST

Owner's Tools

ITEM NAME	PART NUMBER	QUANTITY
GASKET-LIQUID,TUBE,100G,SILVER (Ref # 92104)	92104-002	1
TOOL-WRENCH,BOX,16MM (Ref # 92110)	92110-1162	1