

2007 KLX300R PARTS DIAGRAM

Cylinder Head

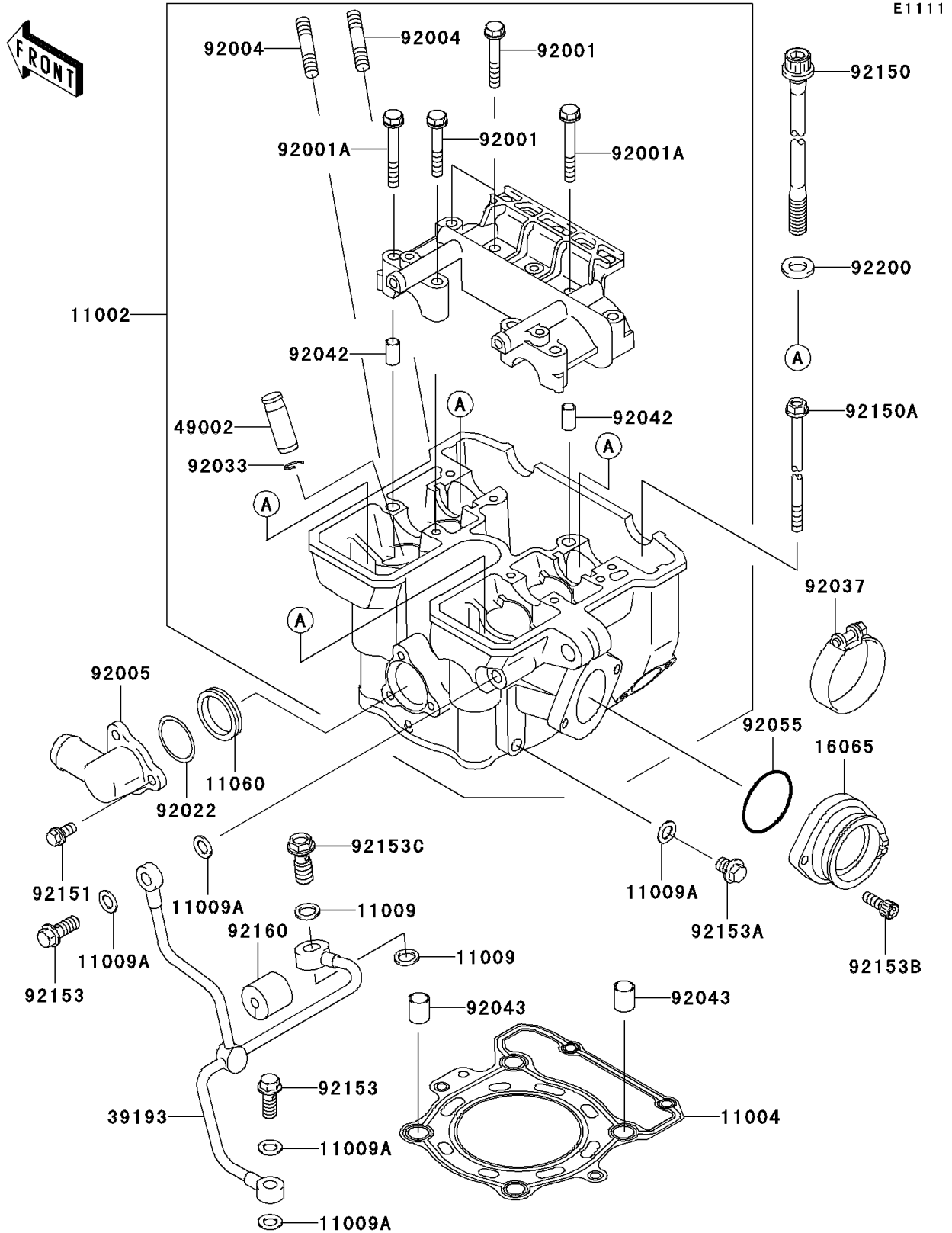

2007 KLX300R PARTS LIST

Cylinder Head

ITEM NAME	PART NUMBER	QUANTITY
HEAD-ASSY-CYLINDER (Ref # 11002)	11002-1322	1
GASKET-HEAD (Ref # 11004)	11004-1314	1
GASKET,10X14.5X1.5 (Ref # 11009)	11009-1105	2
GASKET,8.2X14X1.0 (Ref # 11009A)	11009-1344	5
GASKET,THERMOSTAT (Ref # 11060)	11060-1300	1
HOLDER-CARBURETOR (Ref # 16065)	16065-1283	1
PIPE-OIL (Ref # 39193)	39193-1029	1
GUIDE-VALVE (Ref # 49002)	49002-1126	AR
BOLT,FLANGED,6X38 (Ref # 92001)	92001-1105	6
BOLT,6X46 (Ref # 92001A)	92001-1872	2
STUD,8X22 (Ref # 92004)	92004-1217	2
FITTING (Ref # 92005)	92005-1258	1
WASHER,25.3X30X1 (Ref # 92022)	92022-161	1
RING-SNAP (Ref # 92033)	92033-1247	4
CLAMP,ID=53,BLACK (Ref # 92037)	92037-1304	1
PIN,DOWEL,6.3X8X14 (Ref # 92042)	92042-007	2
PIN,10.1X12X14 (Ref # 92043)	92043-4009	2
RING-O (Ref # 92055)	92055-1255	1
BOLT,10X165 (Ref # 92150)	92150-1368	4
BOLT,6X135 (Ref # 92150A)	92150-1552	2
BOLT,6X12 (Ref # 92151)	92151-1133	3
BOLT,BANJO,8X20 (Ref # 92153)	92153-0651	2
BOLT,FLANGED,8X10 (Ref # 92153A)	92153-1342	1
BOLT,SOCKET,6X16 (Ref # 92153B)	92153-1344	2
BOLT,BANJO,10X23 (Ref # 92153C)	92153-1345	1
DAMPER,6.3X22X20 (Ref # 92160)	92160-1013	1
WASHER,10.5X19X2.3 (Ref # 92200)	92200-1042	4