

# 2007 KLX300R PARTS DIAGRAM

Kickstarter Mechanism

E1340

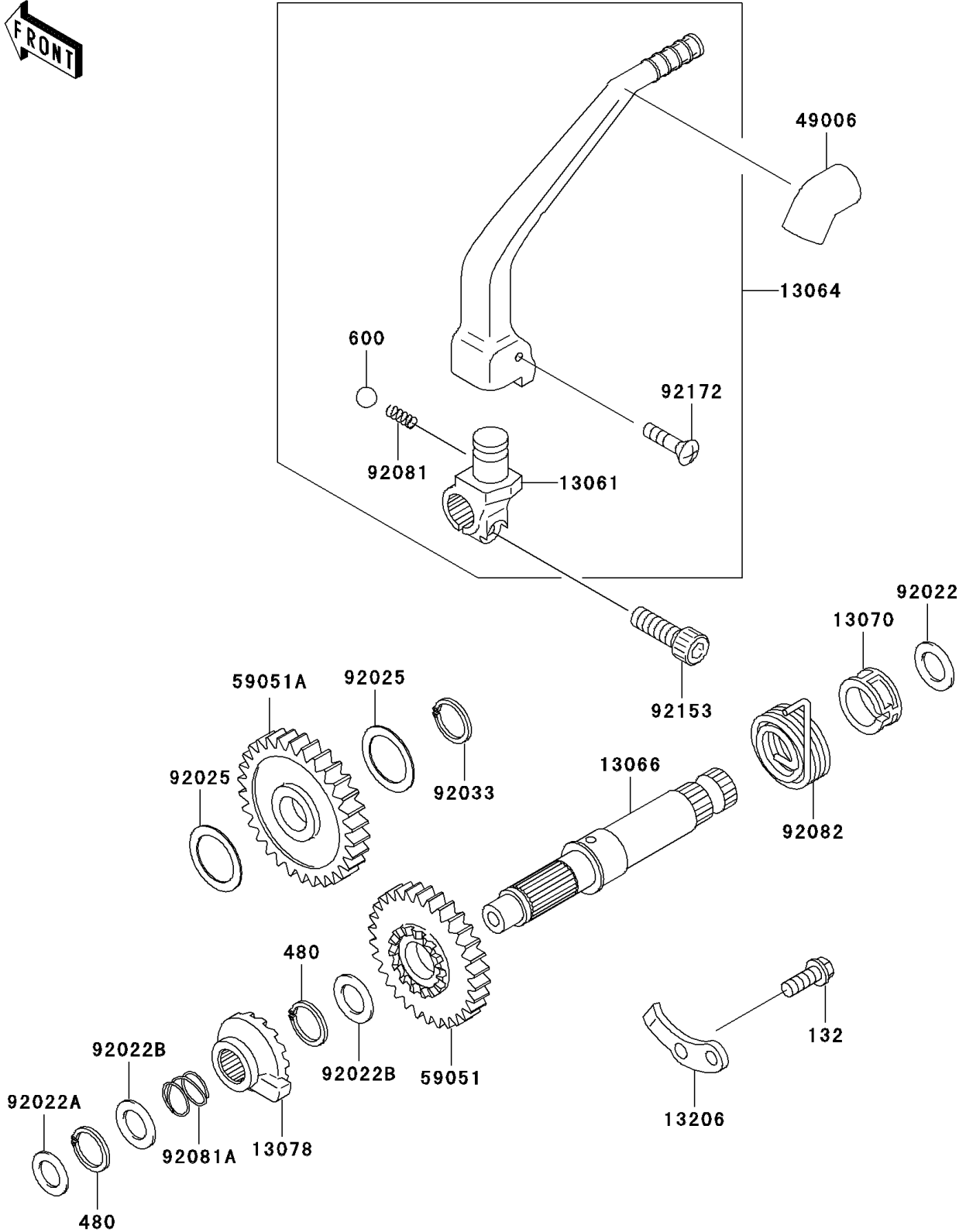

## 2007 KLX300R PARTS LIST

### Kickstarter Mechanism

ITEM NAME	PART NUMBER	QUANTITY
BOLT-FLANGED-SMALL,6X16 (Ref # 132)	132G0616	1
CIRCLIP-TYPE-C,16MM (Ref # 480)	480J1600	2
BALL-STEEL,1/4" (Ref # 600)	600A0800	1
BOSS,KICK PEDAL (Ref # 13061)	13061-1397	1
LEVER-ASSY-KICK,PEDAL (Ref # 13064)	13064-0034	1
SHAFT-KICK (Ref # 13066)	13066-1088	1
GUIDE,KICK SPRING (Ref # 13070)	13070-011	1
RATCHET (Ref # 13078)	13078-1052	1
GUIDE-KICK (Ref # 13206)	13206-1062	1
BOOT (Ref # 49006)	49006-1287	1
GEAR-SPUR,KICK,29T (Ref # 59051)	59051-1131	1
GEAR-SPUR,28T (Ref # 59051A)	59051-1400	1
WASHER,18.5X23X1.2 (Ref # 92022)	92022-118	1
WASHER,12.3X20X0.5 (Ref # 92022A)	92022-269	1
WASHER,16.8X22X0.5 (Ref # 92022B)	92022-315	2
SHIM,T=0.7 (Ref # 92025)	92025-1451	2
RING-SNAP,18MM (Ref # 92033)	92033-029	1
SPRING,KICK PEDAL (Ref # 92081)	92081-020	1
SPRING,RATCHET (Ref # 92081A)	92081-122	1
SPRING,KICKSTARTER (Ref # 92082)	92082-003	1
BOLT,SOCKET,8X25 (Ref # 92153)	92153-1350	1
SCREW,6X27 (Ref # 92172)	92172-0222	1