

2017 Ninja ZX-6R PARTS DIAGRAM

Brake Pedal/Torque Link

F2260

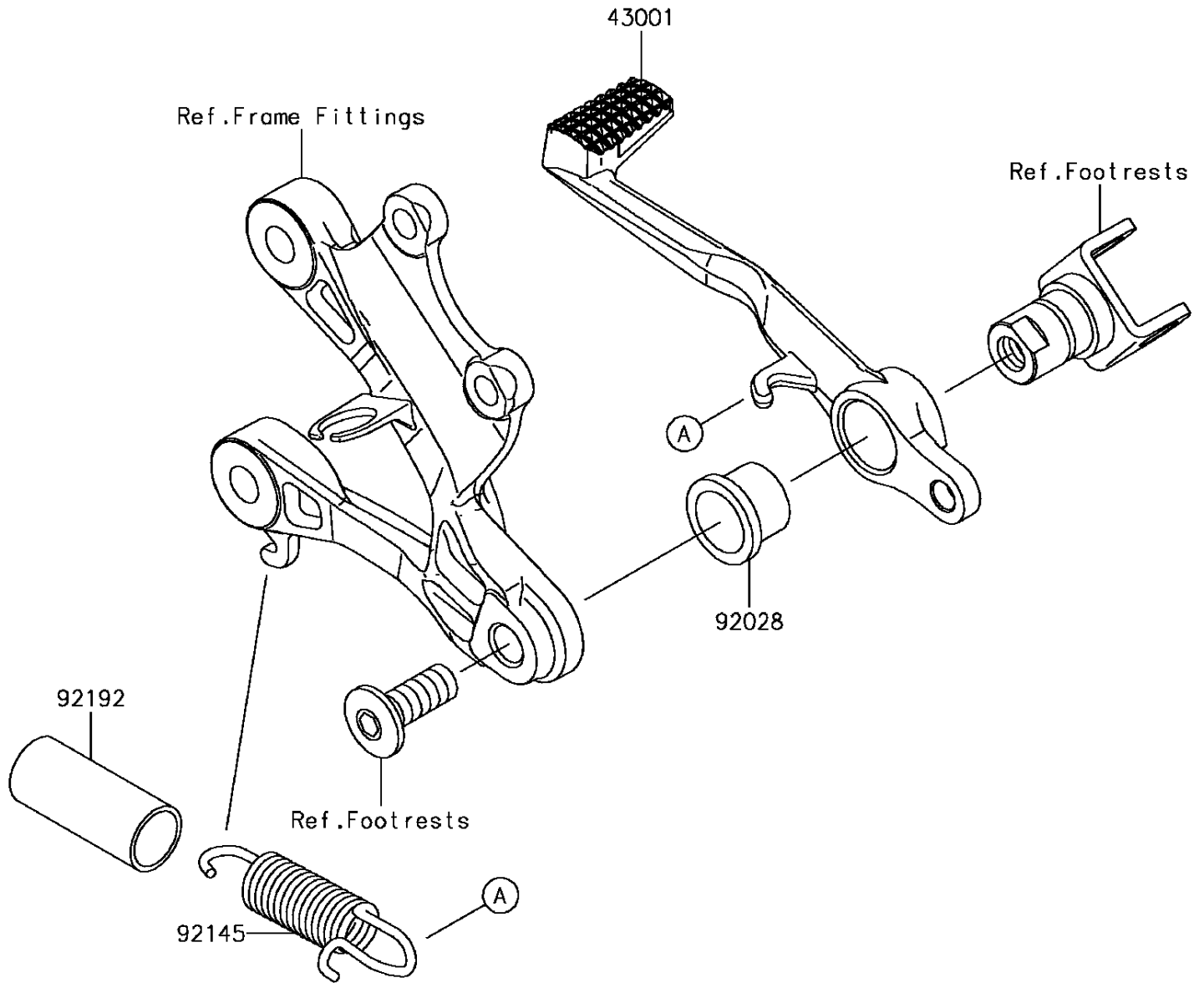

2017 Ninja ZX-6R PARTS LIST

Brake Pedal/Torque Link

| ITEM NAME | PART NUMBER | QUANTITY |
|---|-------------|----------|
| LEVER-BRAKE,PEDAL (Ref # 43001) | 43001-0718 | 1 |
| BUSHING (Ref # 92028) | 92028-1576 | 1 |
| SPRING,BRAKE PEDAL RETURN (Ref # 92145) | 92145-0630 | 1 |
| TUBE,16X19X45 (Ref # 92192) | 92192-0838 | 1 |