

1995 KLX650 PARTS DIAGRAM

Crankcase

E1411

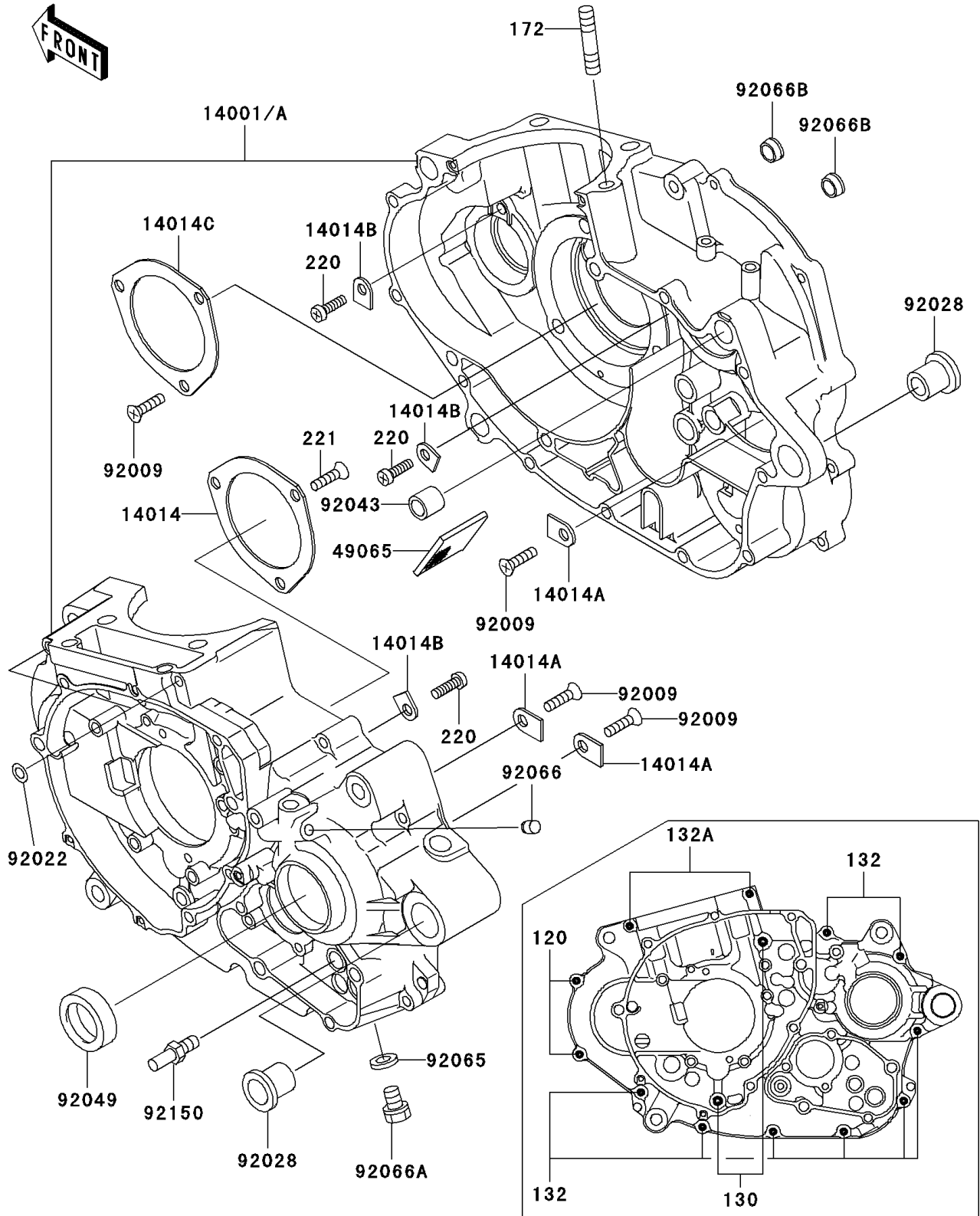

1995 KLX650 PARTS LIST

Crankcase

ITEM NAME	PART NUMBER	QUANTITY
BOLT-SOCKET (Ref # 120)	120Z0640	2
BOLT-FLANGED (Ref # 130)	130Z0865	2
BOLT-FLANGED-SMALL (Ref # 132)	132Y0640	8
BOLT-FLANGED-SMALL (Ref # 132A)	132Y0695	2
BOLT-STUD,8X25 (Ref # 172)	172G0825	1
SCREW-PAN-CROS,6X12 (Ref # 220)	220B0612	3
SCREW-CSK-CROS,6X16 (Ref # 221)	221B0616	3
SET-CRANKCASE (Ref # 14001A)	14001-5338	1
PLATE-POSITION (Ref # 14014)	14014-1051	1
PLATE-POSITION (Ref # 14014A)	14014-1057	3
PLATE-POSITION,ROD (Ref # 14014B)	14014-1080	3
PLATE-POSITION (Ref # 14014C)	14014-1083	1
FILTER-OIL (Ref # 49065)	49065-1071	1
SCREW,8X16 (Ref # 92009)	92009-1703	6
WASHER,6.2X11X1 (Ref # 92022)	92022-304	2
BUSHING (Ref # 92028)	92028-1694	2
PIN,11.5X14X14 (Ref # 92043)	92043-1279	3
SEAL-OIL,TC32457 (Ref # 92049)	92049-1159	1
GASKET,12X22X2,DRAIN PLUG (Ref # 92065)	92065-097	1
PLUG,OIL LINE,7.2X8 (Ref # 92066)	92066-1012	1
PLUG,OIL DRAIN,12X15 (Ref # 92066A)	92066-1174	1
PLUG (Ref # 92066B)	92066-1282	2
BOLT,RETURN SPRING (Ref # 92150)	92150-1803	1