

2017 JET SKI® ULTRA® 310X SE PARTS DIAGRAM

Crankcase

E1411

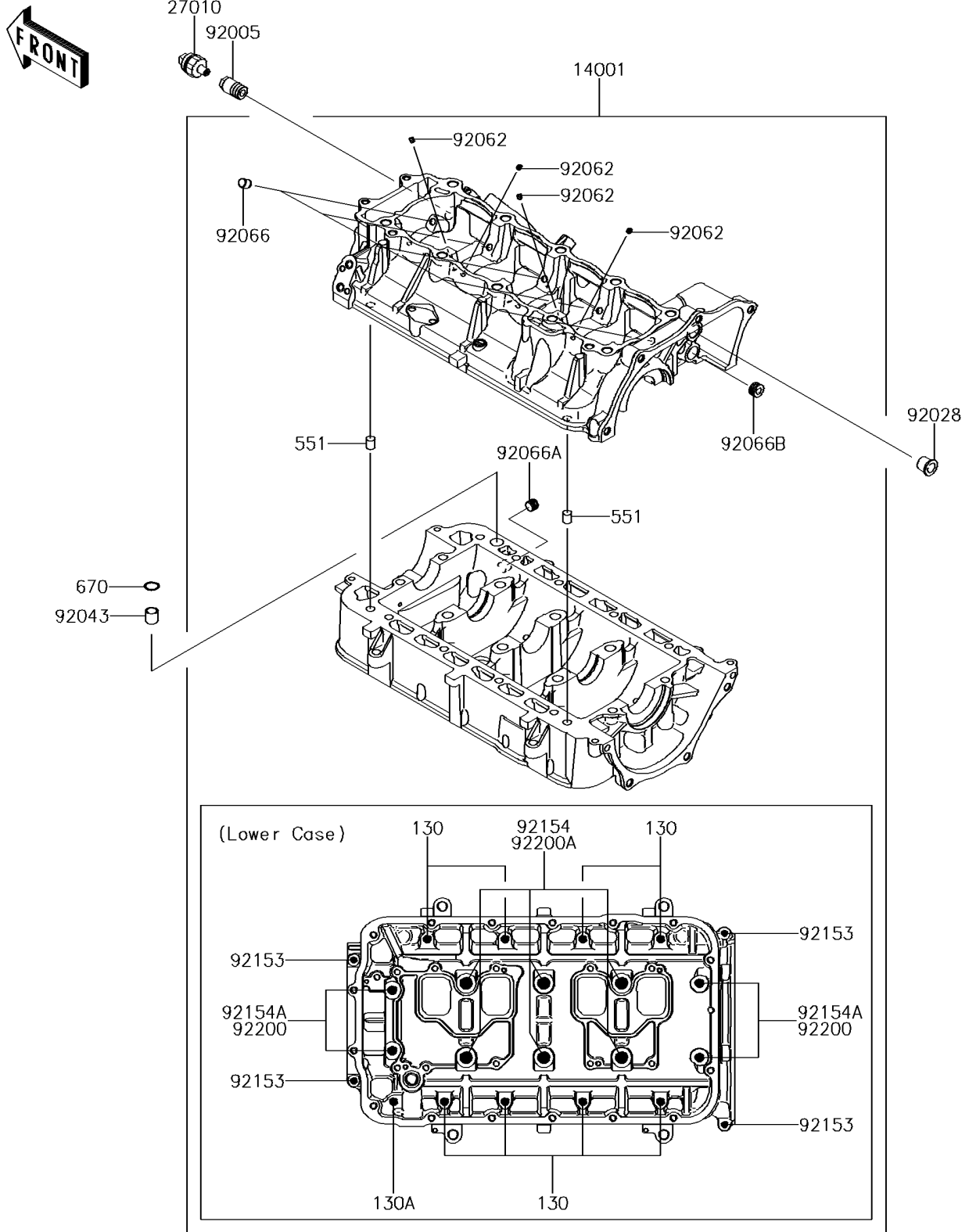

2017 JET SKI® ULTRA® 310X SE PARTS LIST

Crankcase

ITEM NAME	PART NUMBER	QUANTITY
BOLT-FLANGED,8X45 (Ref # 130)	130CD0845	8
BOLT-FLANGED,8X55 (Ref # 130A)	130CD0855	1
SET-CRANKCASE (Ref # 14001)	14001-0614	1
SWITCH,OIL PRESSURE (Ref # 27010)	27010-3786	1
PIN-DOWEL (Ref # 551)	551R1012	2
O RING,14MM (Ref # 670)	670D2014	1
FITTING (Ref # 92005)	92005-0714	1
BUSHING (Ref # 92028)	92028-3718	1
PIN,11.5X14X14 (Ref # 92043)	92043-1279	1
NOZZLE (Ref # 92062)	92062-0029	8
PLUG,OIL LINE,7.2X8 (Ref # 92066)	92066-1012	5
PLUG (Ref # 92066A)	92066-3778	1
PLUG (Ref # 92066B)	92066-3782	1
BOLT,6X30 (Ref # 92153)	92153-3707	4
BOLT (Ref # 92154)	92154-0719	6
BOLT (Ref # 92154A)	92154-0720	4
WASHER (Ref # 92200)	92200-0743	4
WASHER,11.5X20.5X1.6 (Ref # 92200A)	92200-0747	6