

2016 Z250SL PARTS DIAGRAM

Brake Pedal

F2260

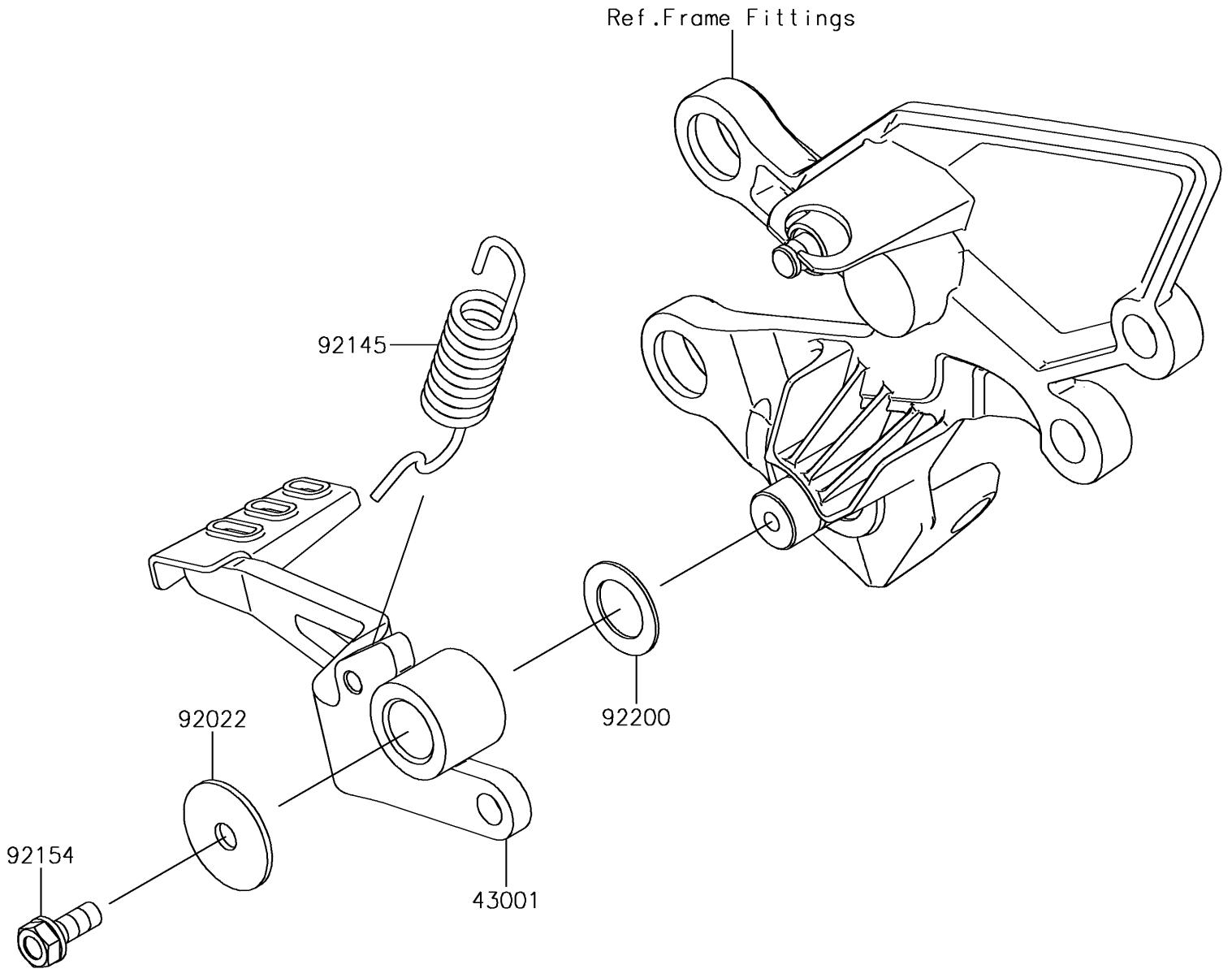

2016 Z250SL PARTS LIST

Brake Pedal

ITEM NAME	PART NUMBER	QUANTITY
LEVER-BRAKE,PEDAL (Ref # 43001)	43001-0726	1
WASHER,7X28X1.6 (Ref # 92022)	92022-1282	1
SPRING,BRAKE PEDAL (Ref # 92145)	92145-0988	1
BOLT,UPSET-WS,6X16 (Ref # 92154)	92154-0935	1
WASHER,15.3X24X1 (Ref # 92200)	92200-0906	1