

1997 Mojave 250 PARTS DIAGRAM

Clutch

E1350

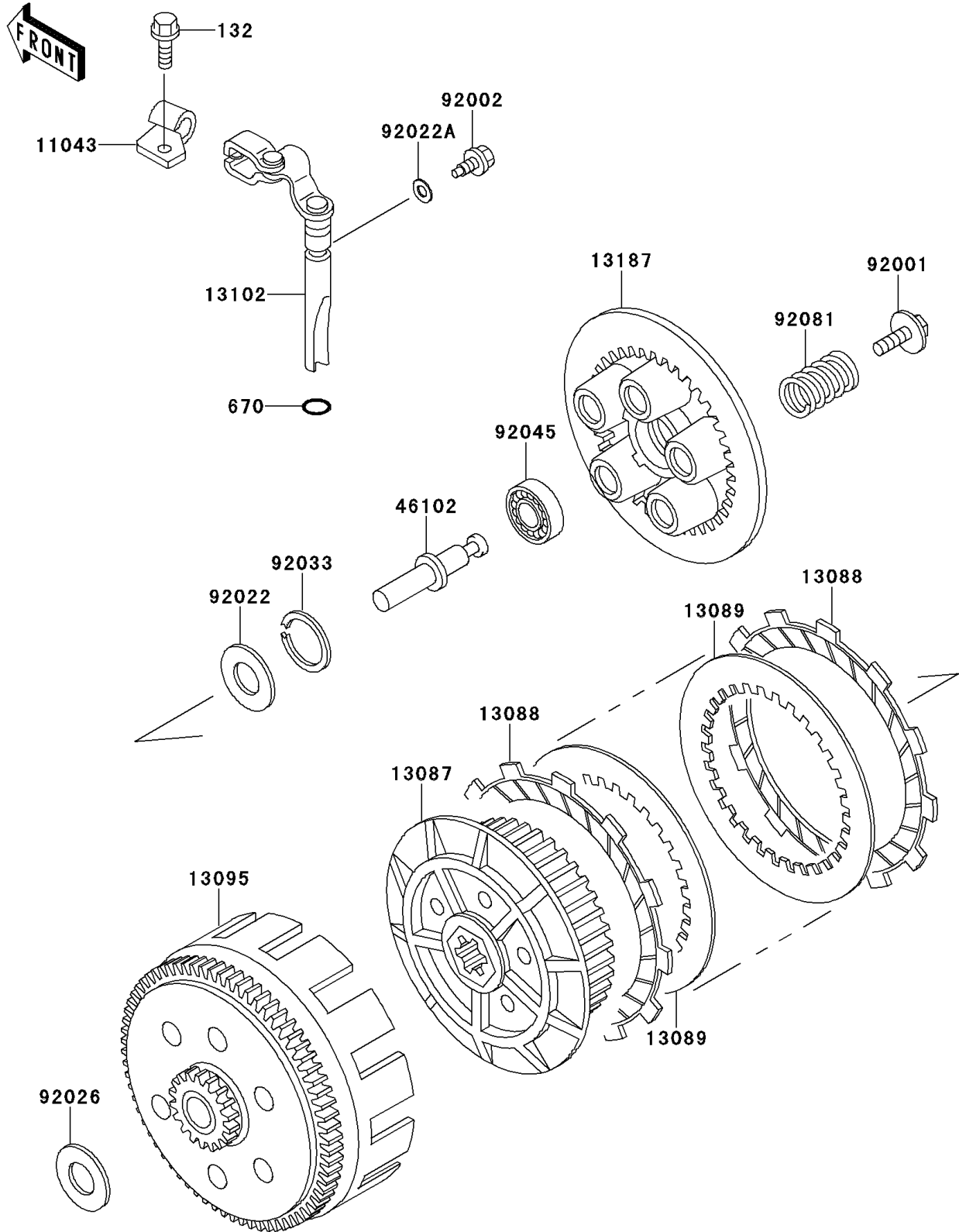

1997 Mojave 250 PARTS LIST

Clutch

ITEM NAME	PART NUMBER	QUANTITY
-----------	-------------	----------