

# 1998 Mojave 250 PARTS DIAGRAM

Gear Change Drum/Shift Fork(s)

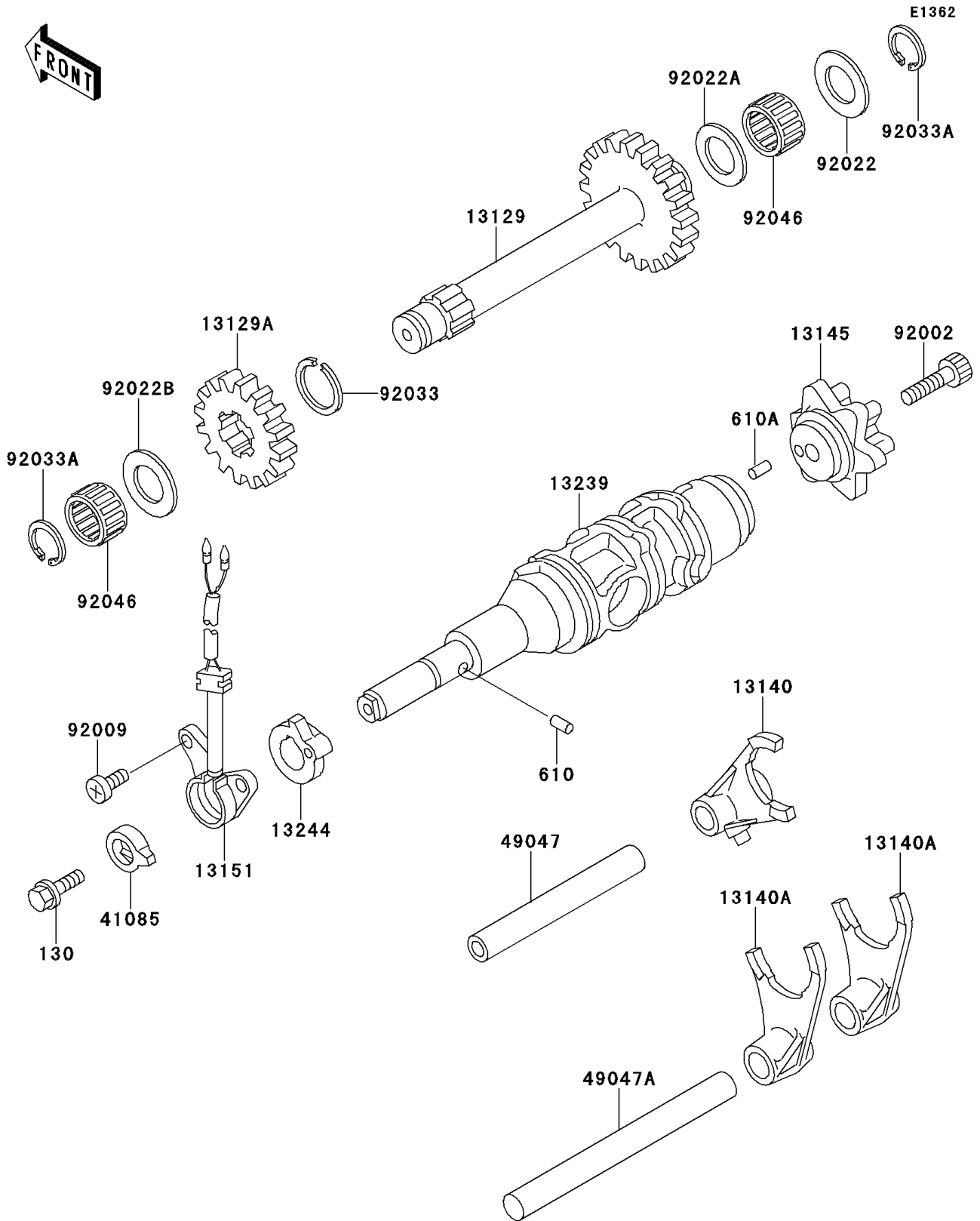

# 1998 Mojave 250 PARTS LIST

Gear Change Drum/Shift Fork(s)

ITEM NAME	PART NUMBER	QUANTITY
-----------	-------------	----------