

2000 Mojave 250 PARTS DIAGRAM

Engine Cover(s)

E1431

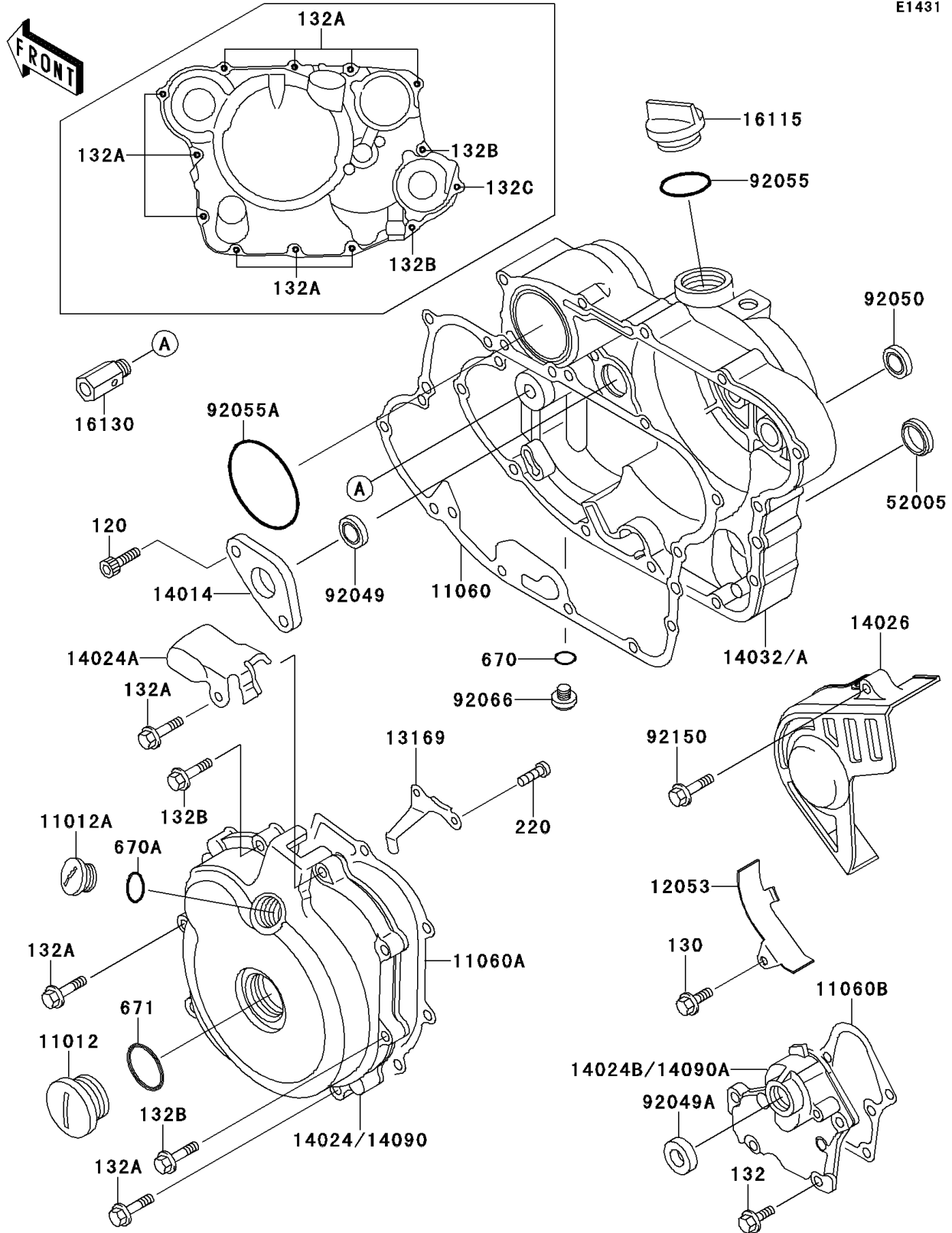

2000 Mojave 250 PARTS LIST

Engine Cover(s)

ITEM NAME	PART NUMBER	QUANTITY
-----------	-------------	----------