

1990 Mojave 250 PARTS DIAGRAM

Cylinder Head

E1111

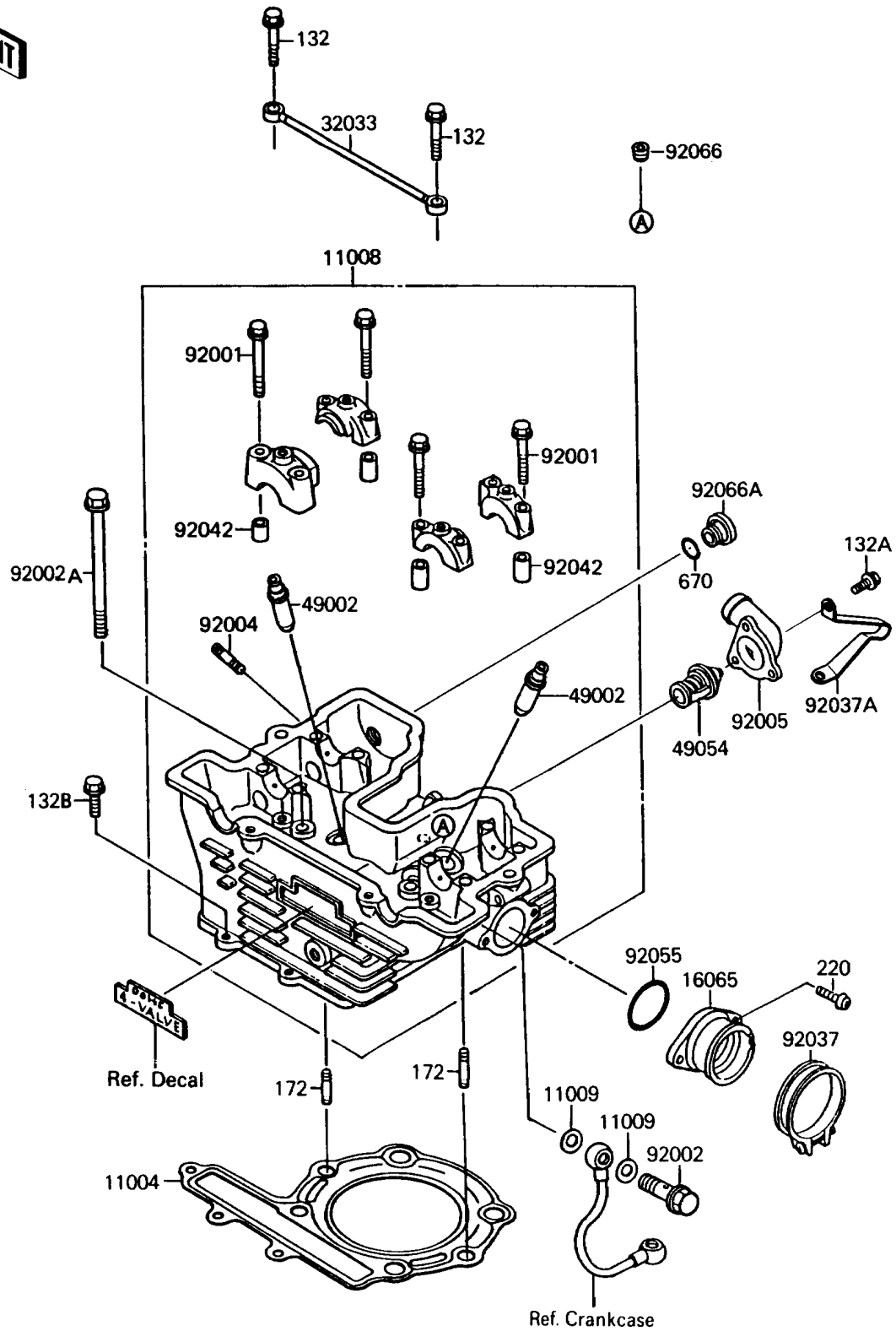

1990 Mojave 250 PARTS LIST

Cylinder Head

ITEM NAME	PART NUMBER	QUANTITY
GASKET-HEAD (Ref # 11004)	11004-1121	1
HEAD-COMP-CYLINDER (Ref # 11008)	11008-1189	1
GASKET,10X14.5X1.5 (Ref # 11009)	11009-1105	2
HOLDER-CARBURETOR (Ref # 16065)	16065-1143	1
PIPE,OIL (Ref # 32033)	32033-1402	1
GUIDE-VALVE (Ref # 49002)	49002-1052	4
THERMOSTAT (Ref # 49054)	49054-1003	1
BOLT,6X46 (Ref # 92001)	92001-1872	8
BOLT,BANJO,10X25 (Ref # 92002)	92002-1170	1
BOLT,L=162 (Ref # 92002A)	92002-1328	4
STUD,8X25 (Ref # 92004)	92004-1008	2
FITTING (Ref # 92005)	92005-1121	1
CLAMP,ID=53,BLACK (Ref # 92037)	92037-1304	1
CLAMP,CLUTCH CABLE (Ref # 92037A)	92037-1984	1
PIN,DOWEL,6.3X8X14 (Ref # 92042)	92042-007	8
RING-O (Ref # 92055)	92055-1255	1
PLUG,1/8X7 (Ref # 92066)	92066-1173	1
PLUG,ROCKER SHAFT (Ref # 92066A)	92066-1188	1
BOLT-FLANGED-SMALL (Ref # 132)	132G0625	2
BOLT-FLANGED-SMALL (Ref # 132A)	132J0612	3
BOLT-FLANGED-SMALL (Ref # 132B)	132J0625	2
BOLT-STUD,8X22 (Ref # 172)	172G0822	2
SCREW-PAN-CROS,6X16,BLACK (Ref # 220)	220C0616	2
O RING,20MM (Ref # 670)	670B2020	1