

2007 ZZR600 PARTS DIAGRAM

Generator

E1810

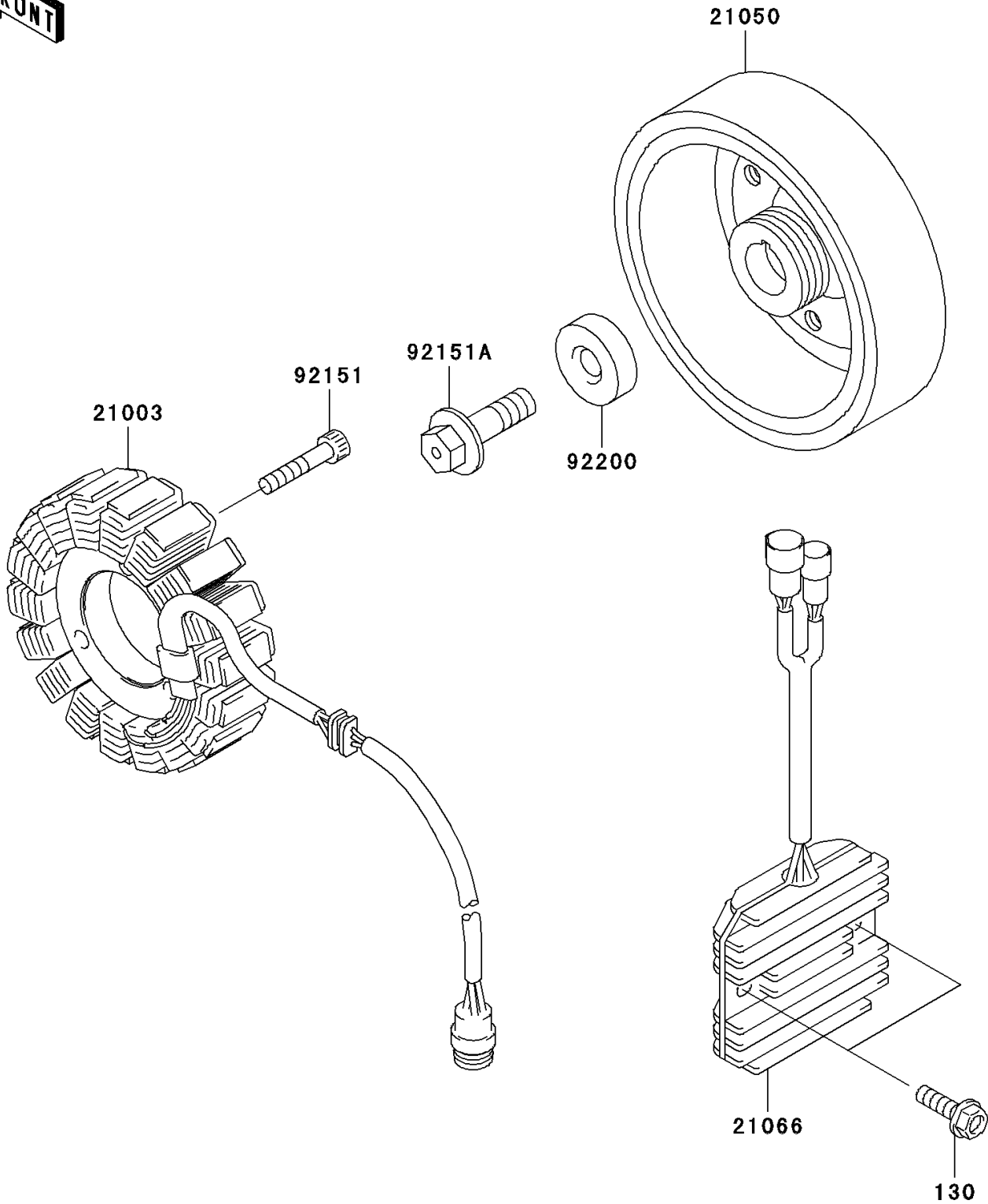

2007 ZZR600 PARTS LIST

Generator

ITEM NAME	PART NUMBER	QUANTITY
BOLT-FLANGED,6X20 (Ref # 130)	130H0620	2
STATOR (Ref # 21003)	21003-1358	1
FLYWHEEL (Ref # 21050)	21050-1190	1
REGULATOR-VOLTAGE (Ref # 21066)	21066-1125	1
BOLT,6X30 (Ref # 92151)	92151-1626	3
BOLT,10X40 (Ref # 92151A)	92151-1653	1
WASHER (Ref # 92200)	92200-1241	1