

2007 Ninja® ZX™-14 PARTS DIAGRAM

Swingarm

F2141

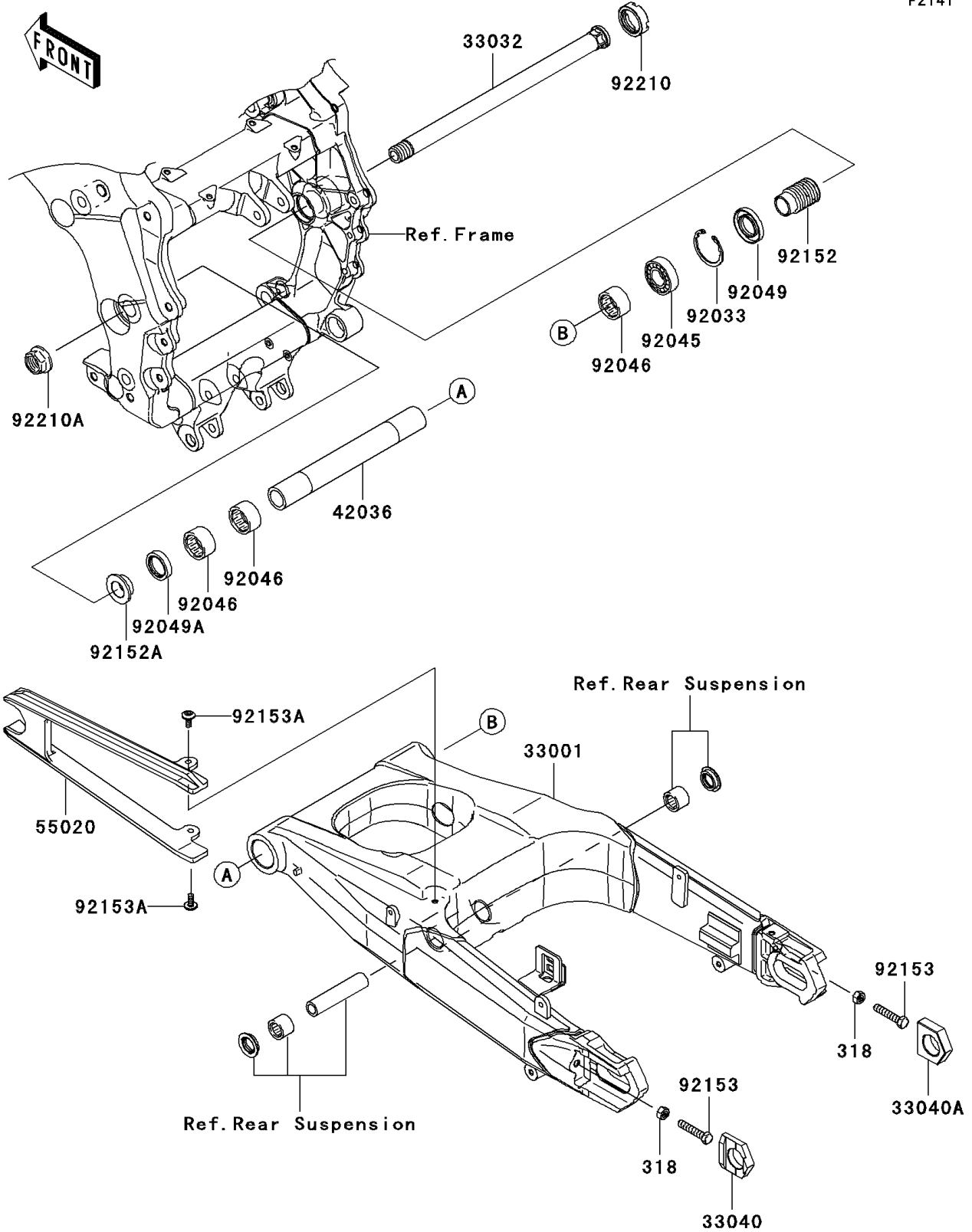

2007 Ninja® ZX™-14 PARTS LIST

Swingarm

ITEM NAME	PART NUMBER	QUANTITY
NUT-HEX-SMALL,8MM (Ref # 318)	318BA0800	2
ARM-COMP-SWING,F.S.BLACK (Ref # 33001)	33001-0073-11E	1
SHAFT-SWING ARM (Ref # 33032)	33032-0013	1
ADJUSTER-CHAIN,LH (Ref # 33040)	33040-0017	1
ADJUSTER-CHAIN,RH (Ref # 33040A)	33040-0018	1
SLEEVE,SWING ARM PIVOT,L=226 (Ref # 42036)	42036-1341	1
GUARD,CHAIN (Ref # 55020)	55020-0206	1
RING-SNAP,42MM (Ref # 92033)	92033-1041	1
BEARING-BALL,6004UL11 (Ref # 92045)	92045-0017	1
BEARING-NEEDLE,7E-HVS 28X34X17 (Ref # 92046)	92046-0008	3
SEAL-OIL,MHSA25 42 6 (Ref # 92049)	92049-1314	1
SEAL-OIL,MHSA25X34X7 (Ref # 92049A)	92049-1352	1
COLLAR,SWING ARM,RH,L=47 (Ref # 92152)	92152-0362	1
COLLAR,SWING ARM,LH,L=12.5 (Ref # 92152A)	92152-0363	1
BOLT,8X55 (Ref # 92153)	92153-1407	2
BOLT,SOCKET,6X14 (Ref # 92153A)	92153-1612	2
NUT,30MM (Ref # 92210)	92210-0134	1
NUT,FLANGED,20MM (Ref # 92210A)	92210-0320	1