

2005 KFX80 PARTS DIAGRAM

Crankshaft

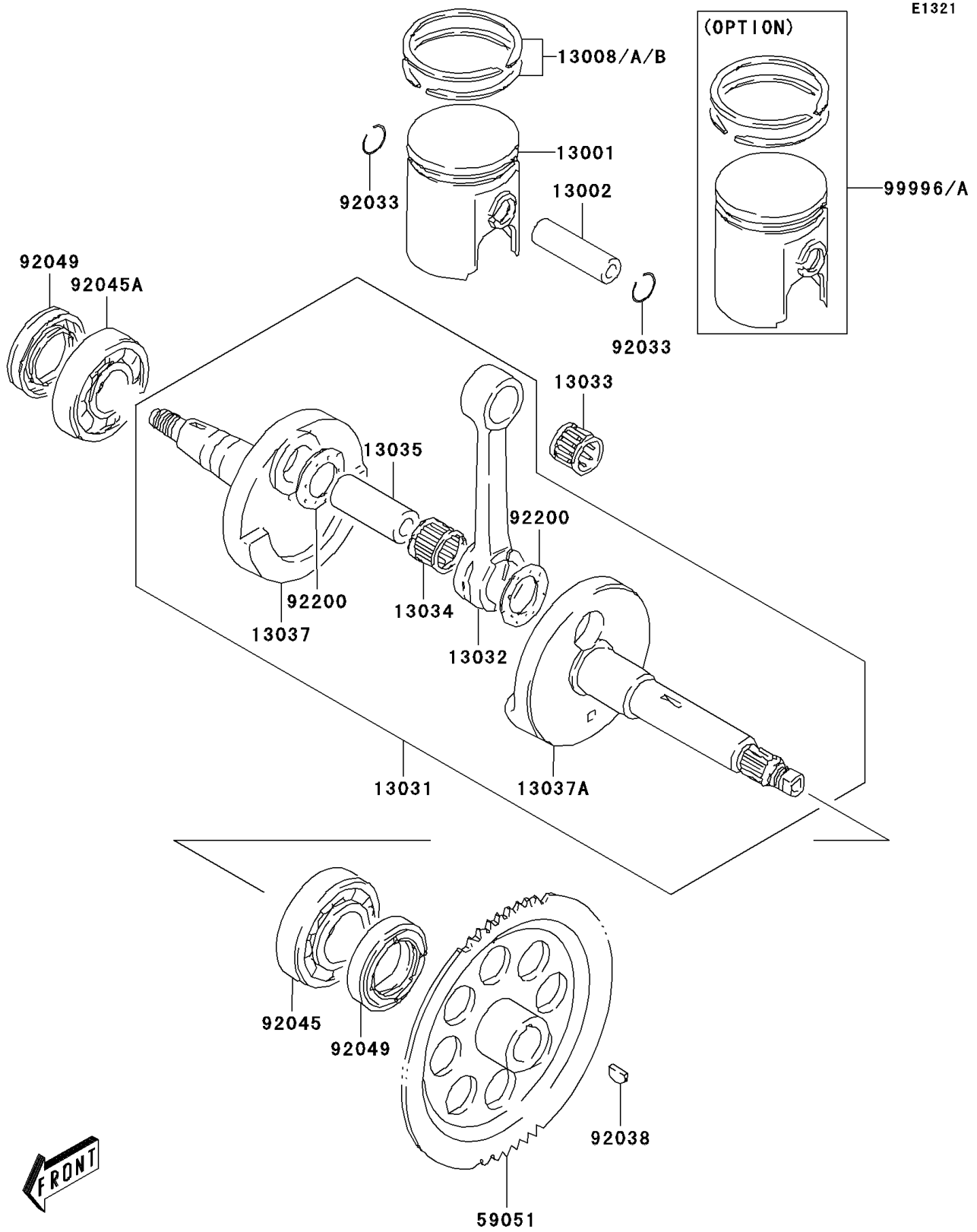

2005 KFX80 PARTS LIST

Crankshaft

ITEM NAME	PART NUMBER	QUANTITY
PISTON-ENGINE (Ref # 13001)	13001-S005	1
PIN-PISTON (Ref # 13002)	13002-S005	1
RING-SET-PISTON,STD (Ref # 13008)	13008-S005	1
RING-SET-PISTON,O/S 0.50 (Ref # 13008A)	13008-S006	1
RING-SET-PISTON,O/S 1.00 (Ref # 13008B)	13008-S007	1
CRANKSHAFT-COMP (Ref # 13031)	13031-S005	1
ROD-CONNECTING (Ref # 13032)	13032-S006	1
BEARING-SMALL END (Ref # 13033)	13033-S001	1
BEARING-BIG END (Ref # 13034)	13034-S005	1
PIN-CRANK (Ref # 13035)	13035-S005	1
CRANKSHAFT,RH (Ref # 13037)	13037-S009	1
CRANKSHAFT,LH (Ref # 13037A)	13037-S010	1
GEAR-SPUR,STARTER (Ref # 59051)	59051-S004	1
RING-SNAP,PISTON PIN (Ref # 92033)	92033-S024	2
KEY,MAGNETO ROTOR (Ref # 92038)	92038-S001	1
BEARING-BALL,20X47X14 (Ref # 92045)	92045-S017	1
BEARING-BALL,CRANKSHAFT,RH (Ref # 92045A)	92045-S039	1
SEAL-OIL,CRANKSHAFT (Ref # 92049)	92049-S034	2
WASHER (Ref # 92200)	92200-S105	2
PISTON SET,O/S 0.50 (Ref # 99996)	99996-S010	1
PISTON SET,O/S 1.00 (Ref # 99996A)	99996-S011	1