

# 1999 Prairie 300 4X4 PARTS DIAGRAM

Air Cleaner

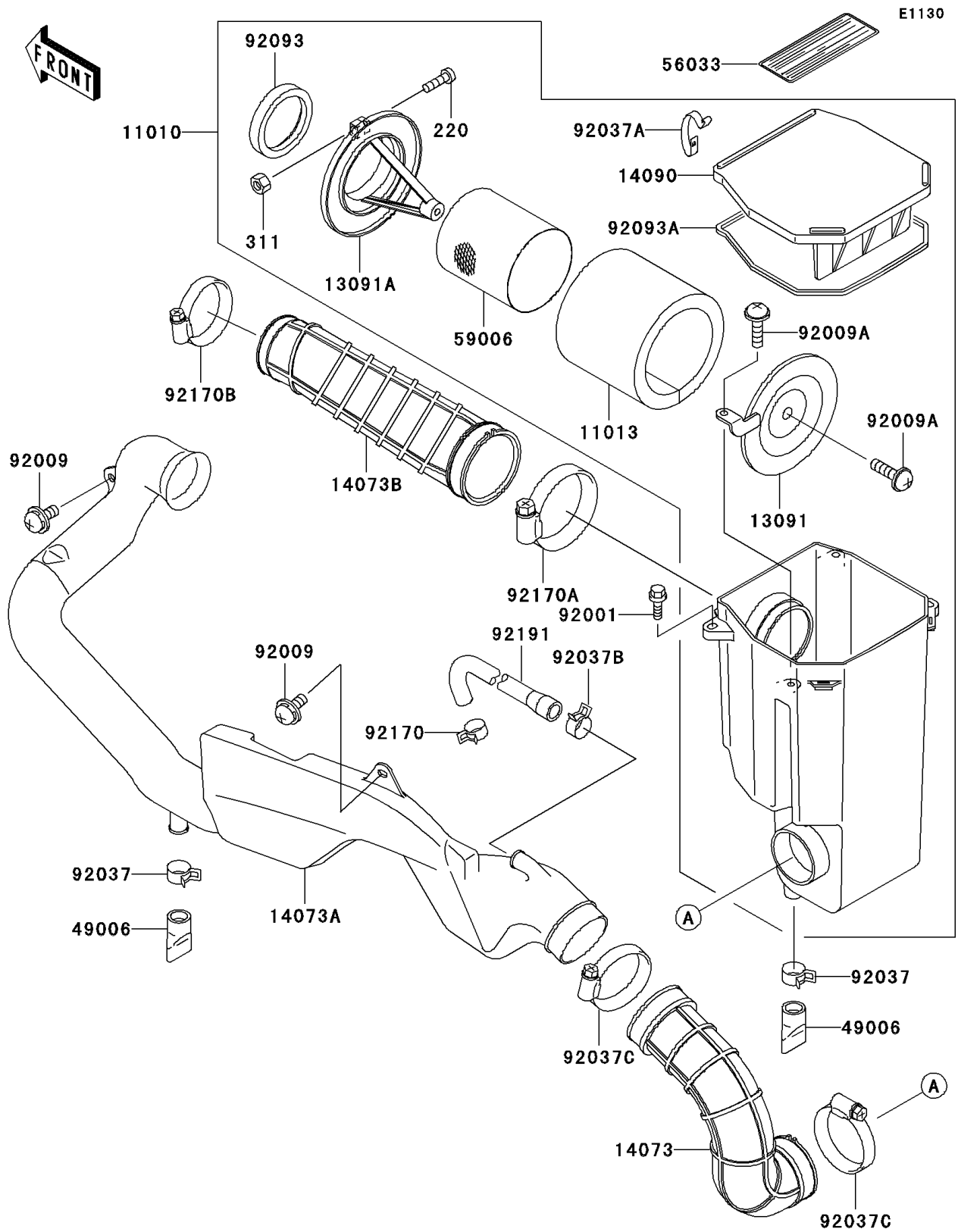

# 1999 Prairie 300 4X4 PARTS LIST

## Air Cleaner

ITEM NAME	PART NUMBER	QUANTITY
SCREW-PAN-CROS,5X16 (Ref # 220)	220B0516	1
NUT-HEX (Ref # 311)	311B0500	1
FILTER-ASSY-AIR (Ref # 11010)	11010-1681	1
ELEMENT-AIR FILTER (Ref # 11013)	11013-1255	1
HOLDER,ELEMENT (Ref # 13091)	13091-1488	1
HOLDER,AIR FILTER ELEMENT (Ref # 13091A)	13091-1565	1
DUCT (Ref # 14073)	14073-1654	1
DUCT (Ref # 14073A)	14073-1682	1
DUCT (Ref # 14073B)	14073-1735	1
COVER,AIR FILTER (Ref # 14090)	14090-1663	1
BOOT (Ref # 49006)	49006-1292	2
LABEL-MANUAL,MAINTENANCE (Ref # 56033)	56033-1079	1
ARRESTER-FLAME (Ref # 59006)	59006-1052	1
BOLT,WP,6X20 (Ref # 92001)	92001-1460	3
SCREW,6X16 (Ref # 92009)	92009-1276	2
SCREW,6X16 (Ref # 92009A)	92009-1890	2
CLAMP (Ref # 92037)	92037-1460	2
CLAMP,AIR FILTER (Ref # 92037A)	92037-1783	4
CLAMP (Ref # 92037B)	92037-1860	1
CLAMP (Ref # 92037C)	92037-3738	2
SEAL,DUST (Ref # 92093)	92093-1322	1
SEAL,FILTER CASE (Ref # 92093A)	92093-1404	1
CLAMP (Ref # 92170)	92170-1491	1
CLAMP (Ref # 92170A)	92170-1679	1
CLAMP (Ref # 92170B)	92170-1764	1
TUBE (Ref # 92191)	92191-1343	1