

2001 Prairie 300 4X4 PARTS DIAGRAM

Engine Cover(s)

E1431

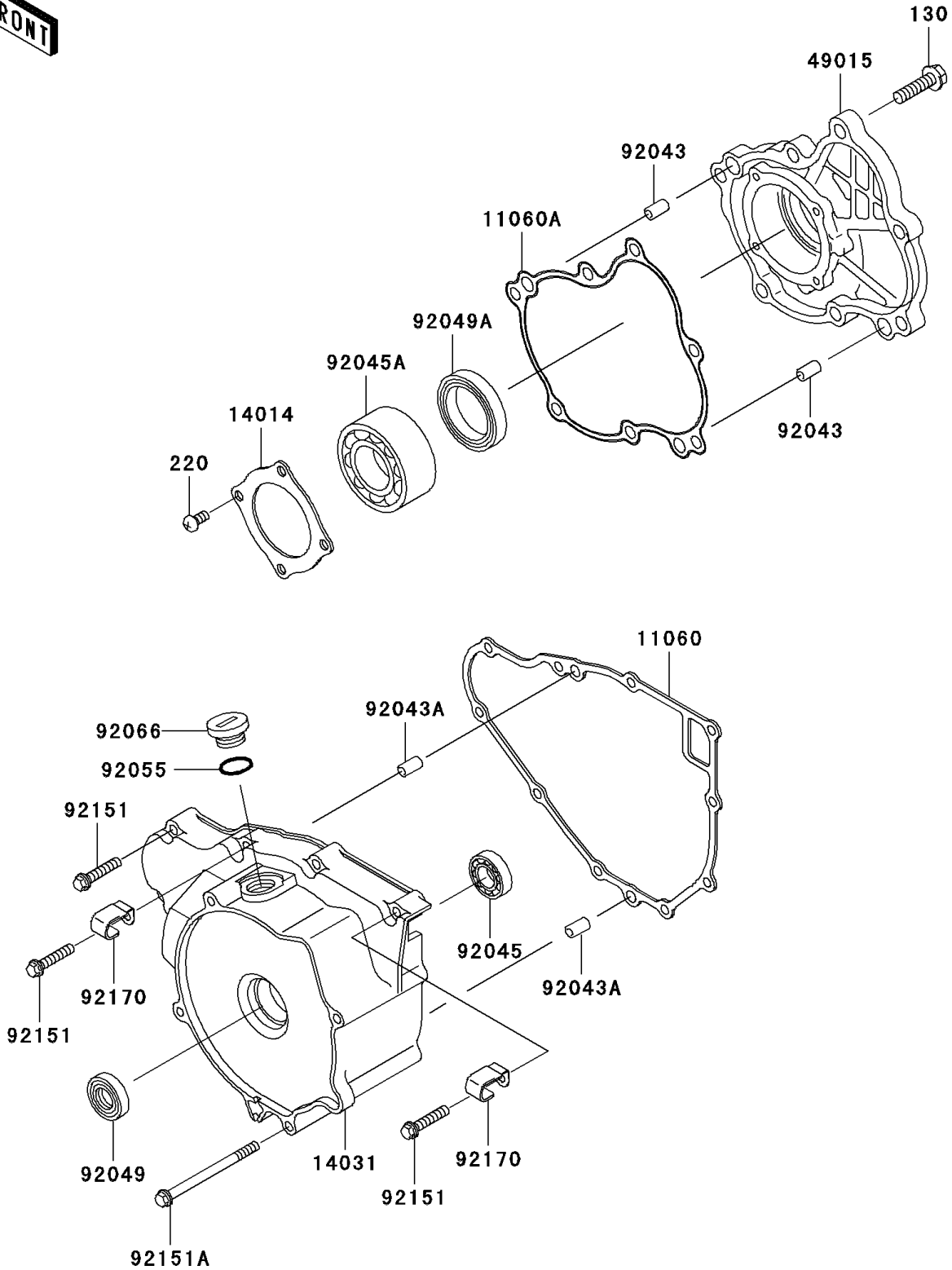

2001 Prairie 300 4X4 PARTS LIST

Engine Cover(s)

ITEM NAME	PART NUMBER	QUANTITY
BOLT-FLANGED,8X30 (Ref # 130)	130P0830	7
SCREW-PAN-CROS,6X12 (Ref # 220)	220B0612	4
GASKET,GENERATOR COVER (Ref # 11060)	11060-1656	1
GASKET (Ref # 11060A)	11060-1850	1
PLATE-POSITION (Ref # 14014)	14014-1138	1
COVER-GENERATOR (Ref # 14031)	14031-1339	1
COVER-CRANKCASE (Ref # 49015)	49015-1055	1
PIN,6.2X8X14 (Ref # 92043)	92043-1263	2
PIN,8.2X10X14 (Ref # 92043A)	92043-1264	2
BEARING-BALL,6903C3 (Ref # 92045)	92045-1266	1
BEARING-BALL,5206 (Ref # 92045A)	92045-1329	1
SEAL-OIL,TC25356 (Ref # 92049)	92049-1317	1
SEAL-OIL,TC30458 (Ref # 92049A)	92049-1451	1
RING-O,20X2 (Ref # 92055)	92055-1146	1
PLUG,COVER (Ref # 92066)	92066-1163	1
BOLT,6X30 (Ref # 92151)	92151-1139	7
BOLT,6X80 (Ref # 92151A)	92151-1430	1
CLAMP (Ref # 92170)	92170-1863	2