

2000 Prairie 300 4X4 PARTS DIAGRAM

Swingarm

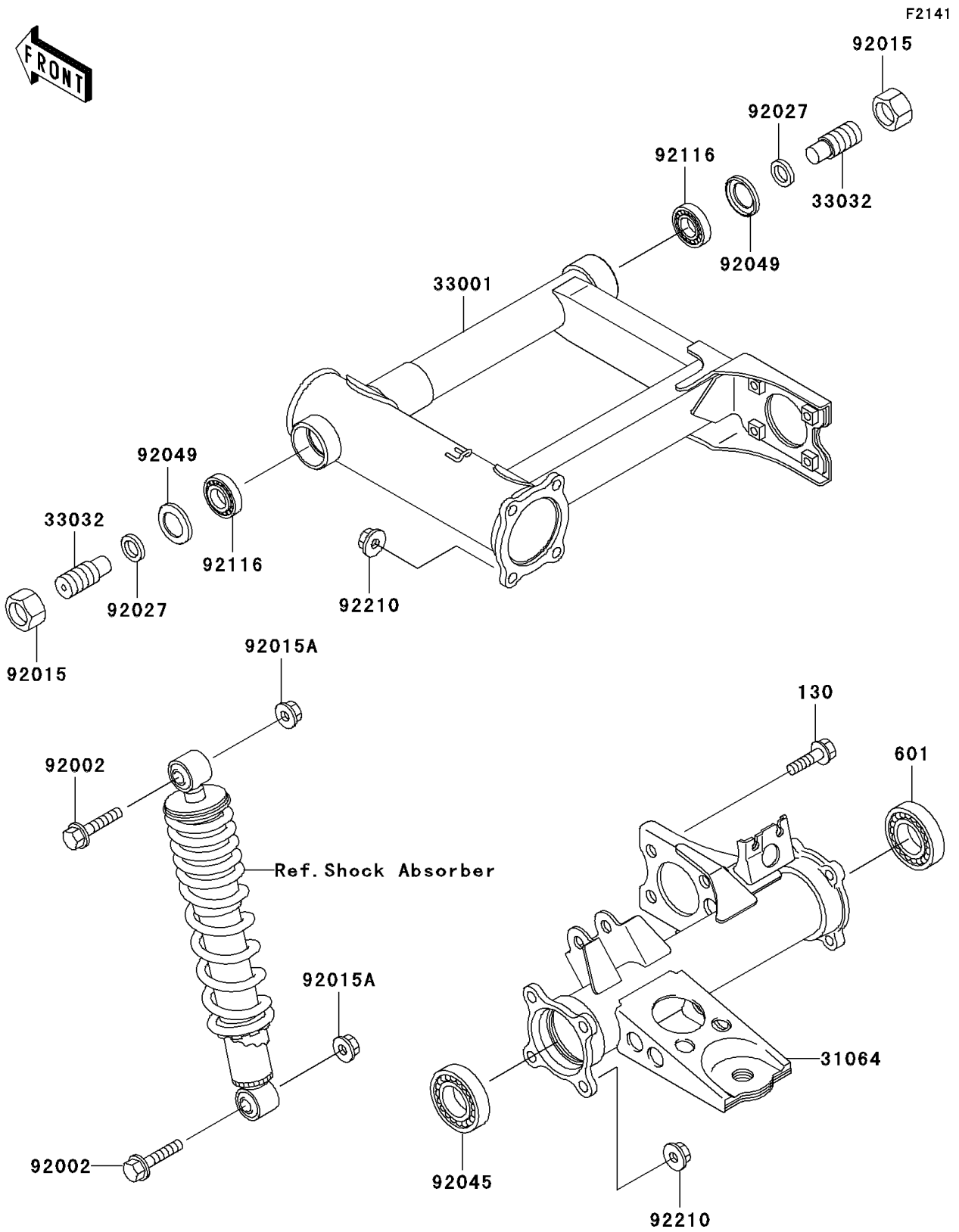

2000 Prairie 300 4X4 PARTS LIST

Swingarm

ITEM NAME	PART NUMBER	QUANTITY
BOLT-FLANGED,10X25 (Ref # 130)	130J1025	4
BEARING-BALL,#6008UU (Ref # 601)	601A6008UU	1
PIPE-COMP (Ref # 31064)	31064-1212	1
ARM-COMP-SWING (Ref # 33001)	33001-1552	1
SHAFT-SWING ARM (Ref # 33032)	33032-1034	2
BOLT,FLANGED,12X55 (Ref # 92002)	92002-1840	2
NUT,22MM (Ref # 92015)	92015-1229	2
NUT,FLANGED,LOCK,12MM (Ref # 92015A)	92015-1617	2
COLLAR,17X26X4.5 (Ref # 92027)	92027-1394	2
BEARING-BALL (Ref # 92045)	92045-1177	1
SEAL-OIL,26406 (Ref # 92049)	92049-1030	2
BEARING-ROLLER,4T30203E1 (Ref # 92116)	92116-1001	2
NUT,LOCK,FLANGED,10MM (Ref # 92210)	92210-1080	8