

2000 Prairie 300 PARTS DIAGRAM

Suspension(B1/B2)

F2150

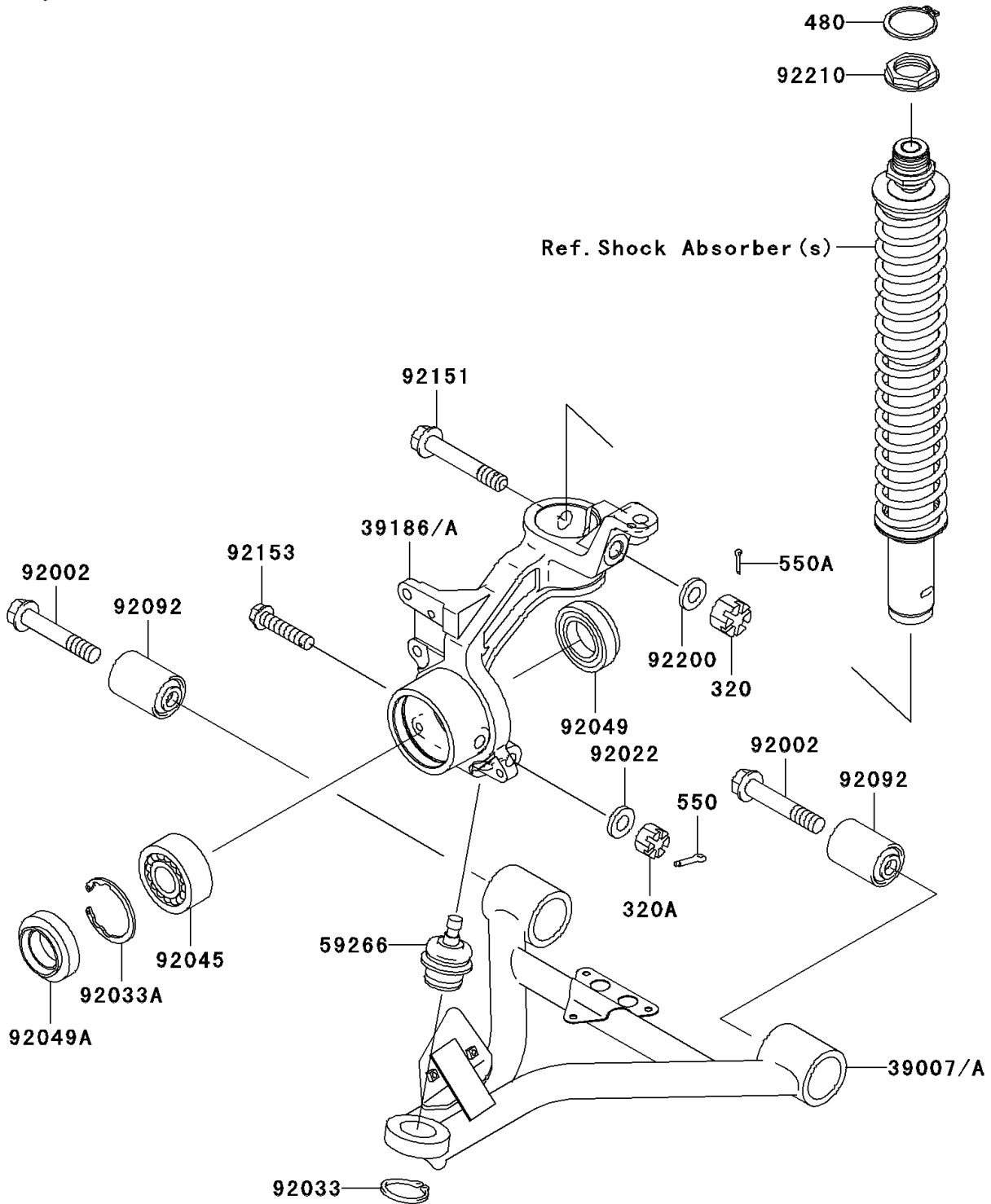

2000 Prairie 300 PARTS LIST

Suspension(B1/B2)

| ITEM NAME | PART NUMBER | QUANTITY |
|---|-------------|----------|
| NUT-CASTLE (Ref # 320) | 320G1200 | 2 |
| NUT-CASTLE (Ref # 320A) | 320H1000 | 2 |
| CIRCLIP-TYPE-C,32MM (Ref # 480) | 480J3200 | 2 |
| PIN-COTTER,2.0X15 (Ref # 550) | 550D2015 | 2 |
| PIN-COTTER,3.0X25 (Ref # 550A) | 550D3025 | 2 |
| ARM-SUSP,FR,LH,LWR (Ref # 39007) | 39007-1259 | 1 |
| ARM-SUSP,FR,RH,LWR (Ref # 39007A) | 39007-1260 | 1 |
| KNUCKLE,FR,LH (Ref # 39186) | 39186-0008 | 1 |
| KNUCKLE,FR,RH (Ref # 39186A) | 39186-0009 | 1 |
| JOINT-BALL (Ref # 59266) | 59266-1098 | 2 |
| BOLT,FLANGED,12X67 (Ref # 92002) | 92002-1861 | 4 |
| WASHER,10.2X16X1 (Ref # 92022) | 92022-1829 | 2 |
| RING-SNAP,30MM (Ref # 92033) | 92033-1218 | 2 |
| RING-SNAP,55MM (Ref # 92033A) | 92033-1274 | 2 |
| BEARING-BALL,DAC3055C2RKCD3 (Ref # 92045) | 92045-1222 | 2 |
| SEAL-OIL,MT038N1 (Ref # 92049) | 92049-1476 | 2 |
| SEAL-OIL,SDD04 38 55 8 (Ref # 92049A) | 92049-1477 | 2 |
| BUSHING-RUBBER (Ref # 92092) | 92092-1076 | 4 |
| BOLT,FLANGED,12X65.5 (Ref # 92151) | 92151-1101 | 2 |
| BOLT,FLANGED,10X44 (Ref # 92153) | 92153-0579 | 2 |
| WASHER,12.3X23X2.3 (Ref # 92200) | 92200-1004 | 2 |
| NUT,35MM (Ref # 92210) | 92210-1066 | 2 |