

# 2002 Prairie 300 PARTS DIAGRAM

Rear Hub

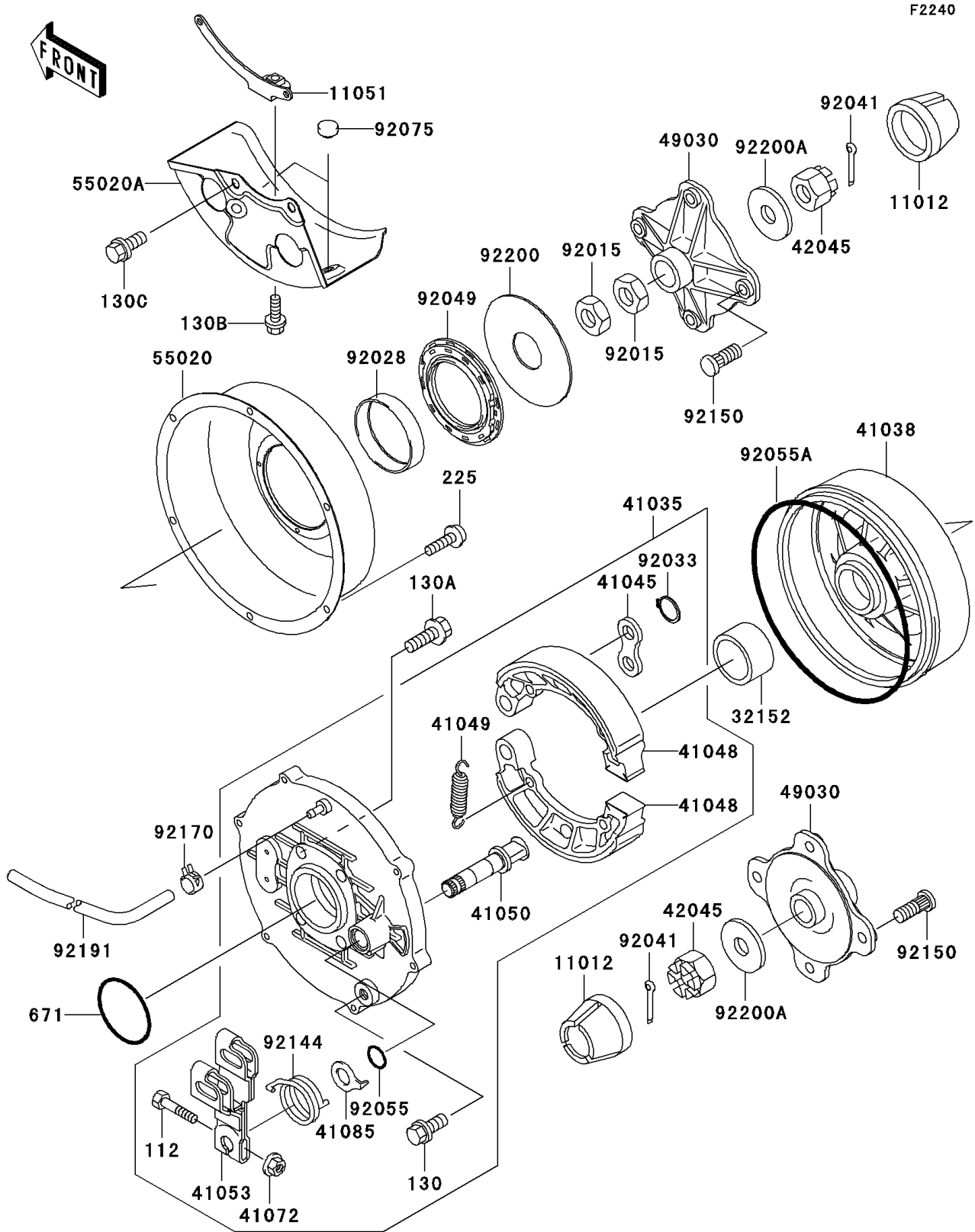

## 2002 Prairie 300 PARTS LIST

### Rear Hub

ITEM NAME	PART NUMBER	QUANTITY
BOLT-UPSET,6X40 (Ref # 112)	112H0640	1
BOLT-FLANGED,10X12 (Ref # 130)	130B1012	1
BOLT-FLANGED,10X30 (Ref # 130A)	130G1030	4
BOLT-FLANGED,8X12 (Ref # 130B)	130J0812	1
BOLT-FLANGED,8X16 (Ref # 130C)	130J0816	2
SCREW-PAN-WSP-CROS,6X16 (Ref # 225)	225C0616	6
O RING,70MM (Ref # 671)	671B2570	1
CAP,WHEEL (Ref # 11012)	11012-1969	2
BRACKET,GUARD (Ref # 11051)	11051-1205	1
PIPE,40X50.8X28 (Ref # 32152)	32152-1082	1
PANEL-ASSY-BRAKE,RR (Ref # 41035)	41035-1500	1
DRUM,REAR BRAKE (Ref # 41038)	41038-1308	1
WASHER (Ref # 41045)	41045-006	1
SHOE-BRAKE (Ref # 41048)	41048-1127	2
SPRING,BRAKE SHOE (Ref # 41049)	41049-012	2
CAM-BRAKE (Ref # 41050)	41050-1089	1
LEVER-BRAKE CAM (Ref # 41053)	41053-1084	1
NUT,6MM (Ref # 41072)	41072-007	1
INDICATOR (Ref # 41085)	41085-1086	1
NUT,CASTLE,18MM (Ref # 42045)	42045-018	2
HUB,RR,LH (Ref # 49030)	49030-1120	2
GUARD,REAR BRAKE (Ref # 55020)	55020-1646	1
GUARD (Ref # 55020A)	55020-1685	1
NUT,LOCK,37MM (Ref # 92015)	92015-1545	2
BUSHING (Ref # 92028)	92028-1865	1
RING-SNAP,15MM (Ref # 92033)	92033-1250	2
COTTER,4.0X35 (Ref # 92041)	92041-1053	2
SEAL-OIL,SD7 64X106X9ZS (Ref # 92049)	92049-1485	1
RING-O,ID=16.4 (Ref # 92055)	92055-1376	1

## 2002 Prairie 300 PARTS LIST

### Rear Hub

ITEM NAME	PART NUMBER	QUANTITY
RING-O (Ref # 92055A)	92055-1582	1
DAMPER (Ref # 92075)	92075-1983	2
SPRING (Ref # 92144)	92144-1365	1
BOLT (Ref # 92150)	92150-1289	8
CLAMP (Ref # 92170)	92170-2042	1
TUBE,4.7X9.5X850 (Ref # 92191)	92191-1292	1
WASHER,37X111X2 (Ref # 92200)	92200-1403	1
WASHER,18.5X52X4.5 (Ref # 92200A)	92200-1474	2